

THE CRITICALITY ACCIDENT IN SAROV



INTERNATIONAL ATOMIC ENERGY AGENCY

THE CRITICALITY ACCIDENT
IN SAROV

The following States are Members of the International Atomic Energy Agency:

| | | |
|-------------------------------------|---------------------------|--|
| AFGHANISTAN | GUATEMALA | PANAMA |
| ALBANIA | HAITI | PARAGUAY |
| ALGERIA | HOLY SEE | PERU |
| ANGOLA | HUNGARY | PHILIPPINES |
| ARGENTINA | ICELAND | POLAND |
| ARMENIA | INDIA | PORTUGAL |
| AUSTRALIA | INDONESIA | QATAR |
| AUSTRIA | IRAN, ISLAMIC REPUBLIC OF | REPUBLIC OF MOLDOVA |
| BANGLADESH | IRAQ | ROMANIA |
| BELARUS | IRELAND | RUSSIAN FEDERATION |
| BELGIUM | ISRAEL | SAUDI ARABIA |
| BENIN | ITALY | SENEGAL |
| BOLIVIA | JAMAICA | SIERRA LEONE |
| BOSNIA AND HERZEGOVINA | JAPAN | SINGAPORE |
| BRAZIL | JORDAN | SLOVAKIA |
| BULGARIA | KAZAKHSTAN | SLOVENIA |
| BURKINA FASO | KENYA | SOUTH AFRICA |
| CAMBODIA | KOREA, REPUBLIC OF | SPAIN |
| CAMEROON | KUWAIT | SRI LANKA |
| CANADA | LATVIA | SUDAN |
| CHILE | LEBANON | SWEDEN |
| CHINA | LIBERIA | SWITZERLAND |
| COLOMBIA | LIBYAN ARAB JAMAHIRIYA | SYRIAN ARAB REPUBLIC |
| COSTA RICA | LIECHTENSTEIN | THAILAND |
| COTE D'IVOIRE | LITHUANIA | THE FORMER YUGOSLAV REPUBLIC OF MACEDONIA |
| CROATIA | LUXEMBOURG | TUNISIA |
| CUBA | MADAGASCAR | TURKEY |
| CYPRUS | MALAYSIA | UGANDA |
| CZECH REPUBLIC | MALI | UKRAINE |
| DEMOCRATIC REPUBLIC OF THE CONGO | MALTA | UNITED ARAB EMIRATES |
| DENMARK | MARSHALL ISLANDS | UNITED KINGDOM OF GREAT BRITAIN AND NORTHERN IRELAND |
| DOMINICAN REPUBLIC | MAURITIUS | UNITED REPUBLIC OF TANZANIA |
| ECUADOR | MEXICO | UNITED STATES OF AMERICA |
| EGYPT | MONACO | URUGUAY |
| EL SALVADOR | MONGOLIA | UZBEKISTAN |
| ESTONIA | MOROCCO | VENEZUELA |
| ETHIOPIA | MYANMAR | VIET NAM |
| FINLAND | NAMIBIA | YEMEN |
| FRANCE | NETHERLANDS | YUGOSLAVIA |
| GABON | NEW ZEALAND | ZAMBIA |
| GEORGIA | NICARAGUA | ZIMBABWE |
| GERMANY | NIGER | |
| GHANA | NIGERIA | |
| GREECE | NORWAY | |
| | PAKISTAN | |

The Agency's Statute was approved on 23 October 1956 by the Conference on the Statute of the IAEA held at United Nations Headquarters, New York; it entered into force on 29 July 1957. The Headquarters of the Agency are situated in Vienna. Its principal objective is "to accelerate and enlarge the contribution of atomic energy to peace, health and prosperity throughout the world".

© IAEA, 2001

Permission to reproduce or translate the information contained in this publication may be obtained by writing to the International Atomic Energy Agency, Wagramer Strasse 5, P.O. Box 100, A-1400 Vienna, Austria.

Printed by the IAEA in Austria
February 2001
STI/PUB/1106

THE CRITICALITY ACCIDENT IN SAROV

INTERNATIONAL ATOMIC ENERGY AGENCY
VIENNA, 2001

VIC Library Cataloguing in Publication Data

The criticality accident in Sarov. — Vienna : International Atomic Energy Agency, 2001.

p. ; 24 cm.

STI/PUB/1106

ISBN 92-0-100101-0

Includes bibliographical references.

1. Nuclear industry — Russia (Federation) — Accidents. 2. Radiological Accident, Sarov, Russia (Federation), 1997. I. International Atomic Energy Agency.

VICL

00-00257

FOREWORD

On 17 June 1997 a physicist working as a senior technician at the Nuclear Centre, Sarov, in the Russian Federation, was severely exposed as a result of a criticality accident with an assembly of high enriched uranium. The exposure, which caused a high neutron radiation dose, led to death within three days despite prompt medical attention.

The Russian authorities requested urgent assistance from the IAEA under the terms of the 1986 Convention on Assistance in the Case of a Nuclear Accident or Radiological Emergency to provide the Clinical Department of the Institute of Biophysics of the Ministry of Health in Moscow with specialized medicines and other diagnostical supplies in the attempt to save the patient's life. Information on the circumstances of the accident and the medical management of the patient was provided to the IAEA. This is the first of two criticality accidents (the other being the accident at Tokaimura in Japan in 1999) on which the IAEA has now issued reports, and it is intended that the reports will contribute to preventing such accidents in the future.

The IAEA wishes to express its gratitude to the Russian authorities for their forthcoming and helpful attitude, which will enable other Member States to benefit from the lessons that can be drawn from the accident. The IAEA also wishes to acknowledge the contributions of physicians, dosimetrists and radiation safety specialists from the Russian Federation and other countries to the drafting and review of this report.

The IAEA officer responsible for the preparation of this publication was I. Turai of the Division of Radiation and Waste Safety.

EDITORIAL NOTE

This report is based on information made available to the IAEA by or through the authorities of the Russian Federation. Neither the IAEA nor its Member States assume any responsibility for consequences which may arise from its use.

The report does not address questions of responsibility, legal or otherwise, for acts or omissions on the part of any person.

The mention of names of specific companies or products (whether or not indicated as registered) does not imply any intention to infringe proprietary rights, nor should it be construed as an endorsement or recommendation on the part of the IAEA.

CONTENTS

| | | |
|------|--|----|
| 1. | INTRODUCTION | 1 |
| 1.1. | Background | 1 |
| 1.2. | Objective | 1 |
| 1.3. | Scope | 2 |
| 1.4. | Structure | 2 |
| 2. | RADIATION PROTECTION AND REGULATORY CONTROL IN THE RUSSIAN FEDERATION | 2 |
| 3. | THE SITE OF THE ACCIDENT | 6 |
| 3.1. | The Russian Federal Nuclear Centre | 6 |
| 3.2. | The critical assembly | 7 |
| 4. | CIRCUMSTANCES OF THE ACCIDENT | 10 |
| 5. | RESPONSE TO THE ACCIDENT | 11 |
| 6. | DOSIMETRIC ANALYSIS | 14 |
| 6.1. | Evaluation of radiation fields during the criticality event | 14 |
| 6.2. | Dose estimates obtained by physical means | 17 |
| 6.3. | Dose estimates obtained by biological dosimetry | 22 |
| 6.4. | Dose estimates obtained by retrospective dosimetry | 23 |
| 7. | MEDICAL TREATMENT OF THE PATIENT | 25 |
| 7.1. | Introduction | 25 |
| 7.2. | Medical response at Sarov | 25 |
| 7.3. | Specialized hospital treatment in Moscow | 26 |
| 8. | FINDINGS OF THE POST-MORTEM INVESTIGATION (AUTOPSY) | 33 |
| 8.1. | Internal organs | 33 |
| 8.2. | Arms after amputation | 35 |

| | |
|---|----|
| 9. FINDINGS AND LESSONS TO BE LEARNED | 36 |
| 9.1. Operating organizations | 36 |
| 9.2. The medical community | 39 |
| REFERENCES | 42 |
| CONTRIBUTORS TO DRAFTING AND REVIEW | 45 |

1. INTRODUCTION

1.1. BACKGROUND

In the course of the development and application of atomic energy and nuclear technologies, a number of radiation accidents have occurred, many of which have been documented in the scientific and medical literature. Some of these accidents have resulted in significant health effects and, occasionally, in fatal outcomes. Very few such accidents, however, have been criticality accidents (such as, for example, a self-sustaining uncontrolled chain reaction in an experimental reactor, in an assembly of fissile material or in fissile materials in a chemical process).

One function of the IAEA since 1987 has been the investigation of the causes and consequences of serious radiation accidents. Accidents that occurred over the period 1940 to 1969 have been discussed in the course of conferences and symposia held by the IAEA [1–3] and included serious criticality accidents in the United States of America and in Belgium [4–7]. Over the period 1970 to 1989 three further criticality accidents were documented, two in the former Soviet Union and one in Argentina, although the information available on both of these is limited [8, 9].

In recent years the IAEA has directed its attention to a number of radiation accidents that have occurred in the industrial and medical use of radioactive sources. IAEA reports have highlighted issues relating to regulatory control, safety procedures and training. Reports on radiation accidents such as those that occurred in Goiânia in Brazil, El Salvador in San Salvador, Hanoi in Viet Nam, Neshvitzh in Belarus, Tammiku in Estonia and San José in Costa Rica [10–17] have considered the causes and consequences of the accidents and the clinical course and medical management of severely overexposed persons, and derived lessons to be learned.

On 17 June 1997 a criticality accident occurred at the Russian Federal Nuclear Centre (formerly known as Arzamas 16) in the town of Sarov, near Nizhnij Novgorod, about 400 km east of Moscow. The accident happened in a routine manipulation of the components of a critical assembly. The overexposed man, a skilled technician, died 66 h later from the effects of his exposure, despite prompt and intensive medical management. This was thus a very rare type of fatality.

1.2. OBJECTIVE

The objective of this report is to provide information to national authorities and regulatory organizations, emergency planners, research workers in the field of nuclear physics, and a broad range of specialists, including physicists, technicians and medical specialists, and people responsible for nuclear safety and radiation

protection. In particular, the report concludes with lessons to be learned so that steps can be taken to avoid such accidents in the future and to minimize the consequences of any such accidents that do occur.

1.3. SCOPE

The report describes the immediate response to the emergency, including the actions taken to return the facility to a safe condition. It describes various technical aspects of the accident, response and medical management of the patient, and gives lessons to be learned. It does not consider the direct causes of the accident or the reasons or responsibility for actions or omissions on the part of any person.

1.4. STRUCTURE

The report gives a brief description of the relevant regulatory arrangements in the Russian Federation (Section 2). It then describes the facility in which the accident occurred (Section 3), the circumstances of the accident itself (Section 4) and the measures taken to make the facility safe (Section 5). It gives an account of the physical and biological dosimetric investigations (Section 6), and the clinical course and treatment of the fatal radiation injury (Section 7). It includes a description of the findings of the post-mortem investigation (Section 8). This account of the accident is based on information made available to the IAEA by or through the authorities of the Russian Federation. The report concludes with a discussion of the lessons that can be learned from the accident (Section 9).

2. RADIATION PROTECTION AND REGULATORY CONTROL IN THE RUSSIAN FEDERATION

In the Russian Federation a number of government ministries, commissions, other government bodies and other special groups have responsibilities in the areas of radiation protection and nuclear safety. These responsibilities concern regulation and supervision of the production of nuclear materials and atomic energy, the safety of the public and emergency medical response in the event of accidents.

The functions of the Ministry for Atomic Energy [18, 19] include ensuring the safety of federal nuclear installations, managing radioactive waste and managing contaminated areas. It has responsibility for establishing and enforcing the state regulations applying to nuclear enterprises and organizations. It also has

responsibility for elaboration of the policy of the state in relation to the future development of nuclear energy.

Prior to 1996 all aspects of radiation protection and safety in the Russian Federation were regulated in accordance with the documents (standards and guidelines) published by the Soviet National Commission on Radiation Protection before 1990. This system took into account national experience with ionizing radiation in the areas of production, storage, transport and uses of radioactive materials, and incorporated pre-1990 recommendations of the International Commission on Radiological Protection (ICRP). In 1996 a revised set of standards, the Russian Radiation Safety Standards (NRB-96), were issued [20]. The Russian radiation safety standards take into account the recommendations and guidance given in ICRP Publication No. 60 [21] as well as the requirements and recommendations of the International Basic Safety Standards (BSS) [22]. Compliance with the Russian Radiation Safety Standards is mandatory for all organizations and enterprises in the Russian Federation dealing with the production, storage, transport and use of radioactive materials, and using sources of ionizing radiation. Further operational control of these activities is a function of the relevant government ministries and departments.

In the Russian Federation a system for disaster management at the governmental level has been established. The organizational structure of this system is shown in Fig. 1. The main co-ordinating function is with the Interministerial Commission for Disaster Prevention and Response. Under this commission a specialized ministry, the Ministry for Emergency Situations, has been established. This ministry has been assigned considerable resources and possesses the necessary capabilities to protect the general population and deal with the consequences of any major accident or natural disaster in the Russian Federation. In the event of a radiation emergency, the Ministry for Emergency Situations works in co-operation with the Ministry for Atomic Energy [23, 24].

The Ministry for Atomic Energy co-ordinates the system of technical support for nuclear emergencies, as shown in Fig. 2. Within the Ministry for Atomic Energy there is a Department for Nuclear and Radiation Safety, Ecology, Emergency Response and Radioactive Waste Management. This department includes the Centre for Control, Accident Assessment and Decision Making, which maintains a continuous (24 h/d) state of readiness. An important function of the Centre for Control, Accident Assessment and Decision Making is the reception and timely transmission of information about accidents involving hazardous facilities, and to assist with this it has capabilities for real time display of data and rapid communication of information in emergencies. It also maintains databases giving details of specialists and consultants in the fields of research relating to, and design and construction of, nuclear facilities. The centre also develops recommendations for cleanup operations following emergencies.

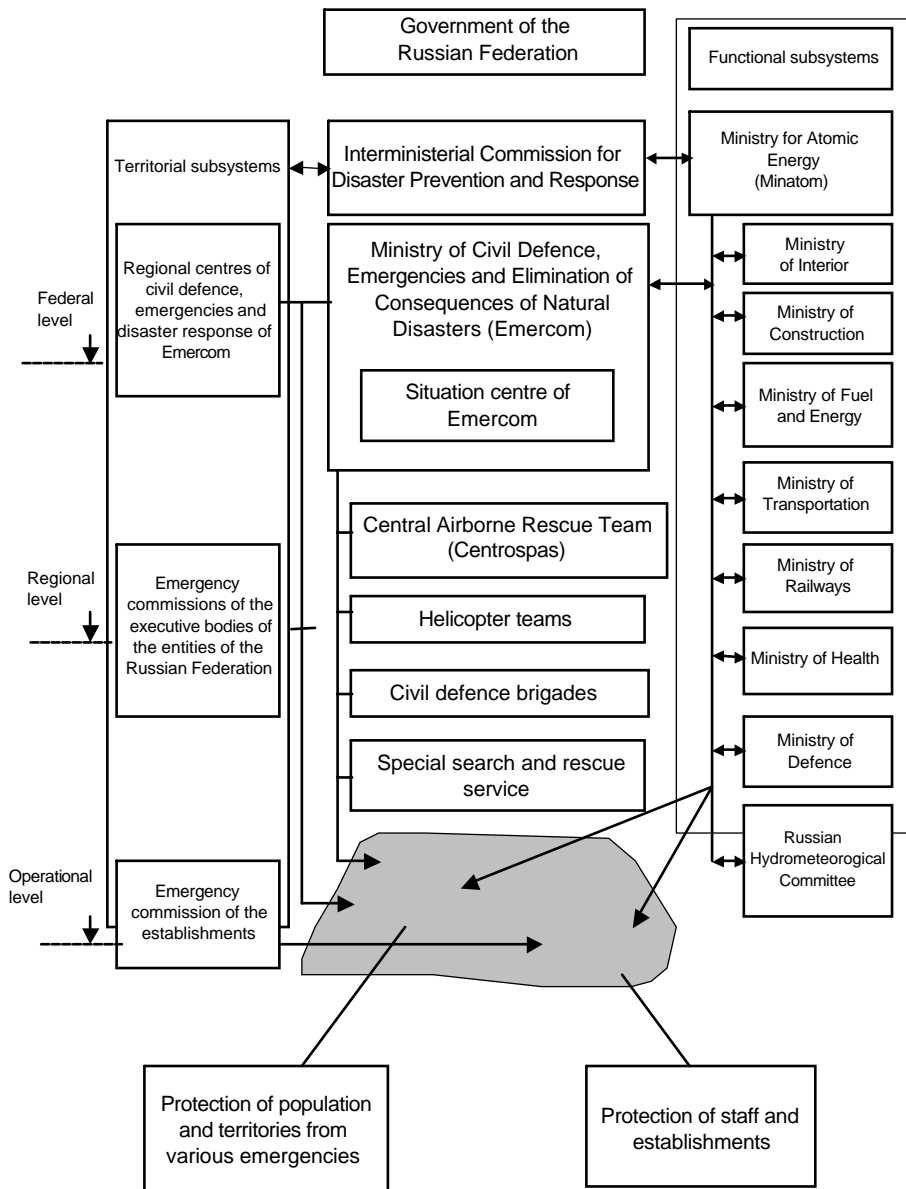

FIG. 1. The Russian system for disaster management.

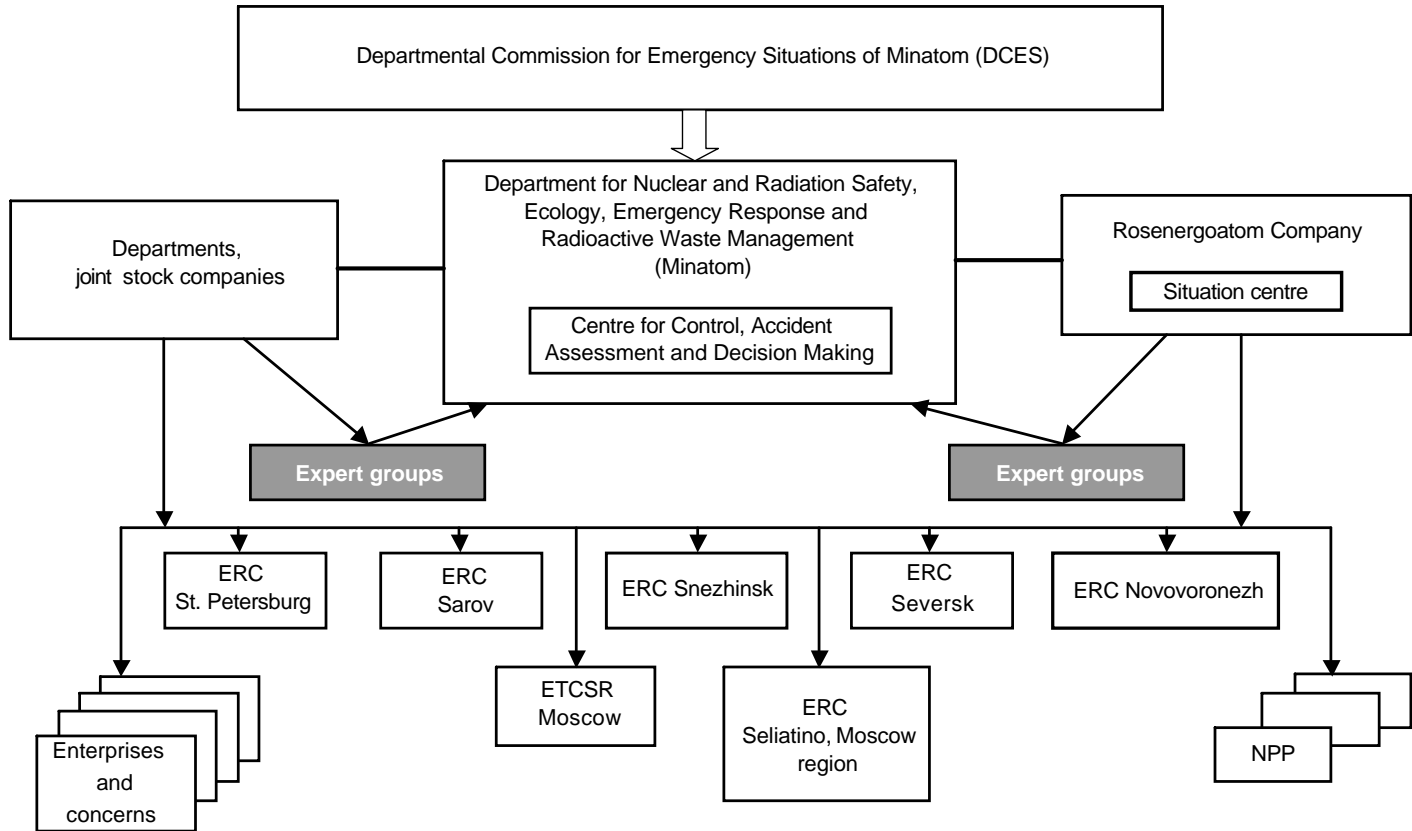

FIG.2. The system of emergency technical support of the Ministry for Atomic Energy. ERC: emergency response centre; NPP: nuclear power

To assist in the response to any emergencies at nuclear facilities that fall under the Ministry for Atomic Energy, five emergency centres have been established in St. Petersburg, Sarov, Snezhinsk, Seversk and Novovoronezh. Each emergency centre is tasked with responding to emergencies occurring in its geographical area which requires special capabilities appropriate to the hazards that might be encountered in the particular area. However, these emergency centres can also operate in response to emergencies occurring in other areas at the direction of the Ministry for Atomic Energy. There are also other organizations and emergency response teams that may be called upon in an emergency, some of which are shown in Figs 1 and 2. Overall, this system of disaster management allows for a range of specialized resources to be made available in the event of an emergency.

3. THE SITE OF THE ACCIDENT

3.1. THE RUSSIAN FEDERAL NUCLEAR CENTRE

The Russian Federal Nuclear Centre, whose Russian acronym is VNIIEF, was established in the town of Sarov in 1946. The centre is organized into research, design, development and experimental divisions [25]. Over the past years, testing grounds and hundreds of experimental facilities have been constructed.

The centre, which is the Russian Federation's largest research and development organization, has capabilities in high level theoretical, experimental and technological research. It employs scientific and engineering staff in theoretical and applied studies, including research in nuclear and radiation physics. The research covers:

- Transformation of explosive energy into high and ultra-high magnetic fields;
- Theoretical and experimental studies in gas discharge and plasma physics;
- Transmission of nuclear radiation through various media, radiation-matter interactions and comprehensive studies of radiation resistance for a wide range of materials and products;
- Numerical and experimental studies on fusion and laser physics problems;
- Studies of fission physics, criticality and chain reaction control.

Experimental studies in the fields of physics, radiobiology and the health effects of radiation are conducted in 12 nuclear facilities, one of which is the critical assembly in Sarov in which the accident described in this report happened. All of these facilities were designed at the centre.

3.2. THE CRITICAL ASSEMBLY

The critical assembly, which is described in Refs [26, 27], was designed as an experimental tool to study fission reactions relevant to the design and development of power reactors and research and impulse reactors. It is located in a purpose built facility (see Fig. 3).

In accordance with documented procedures, a known subcritical portion of the assembly is constructed and then moved to a position from which it can be raised and lowered by a motor (see Figs 4 and 5). Thorough preliminary calculations as well as experience from previous experiments are employed in ensuring that the assembly remains in a subcritical state during this stage of the work. Safety measures taken include a requirement for an experiment controller (supervisor) to be present in the experimental hall (in addition to the technician who constructs the assembly). Additionally, the neutron flux from a ^{252}Cf source placed at the centre of the fissile material is observed. This flux is constantly measured and is displayed visually in the working area as well as being converted into a click audible on a loudspeaker.

The construction process itself involves successive layering of various materials, including copper, steel and uranium, which are prepared in the form of sets of machined hemispherical shells of standard sizes which the technician can assemble into various configurations.

After the lower part of the assembly has been fully constructed, it is moved down to its lowest position. Then, on the stationary upper platform of the assembly (see Figs 4 and 5) the remaining upper reflector components are assembled. The technician then leaves the experimental hall. Movement of the components of the assembly into the critical configuration and the experimental measurements are performed remotely from other rooms separated from the experimental hall by protective concrete walls several metres thick.

When the assembly has been brought to the critical condition it is essentially a low power fast reactor. Such a system has the capability to regulate itself as follows. If the reactor's power is enhanced there will be an increase in temperature of the material, leading to heat expansion of the various components. This changes the configuration of the assembly, which reduces the rate of nuclear reactions. This behaviour is observable as sharp fluctuations of the measured neutron flux, which stabilizes after several cycles, after which the critical assembly operates at a constant level of neutron yield. Temperature sensors and gamma and neutron detectors are used to monitor the condition of the assembly and constant feedback of data is used to control the precise relative positioning of its upper and lower parts.

The design of the experimental building takes into account the worst case accident scenario, in which the criticality condition is sufficiently exceeded such that the components of the assembly melt. As this could lead to high contamination levels, the building incorporates a containment to prevent the spread of any contamination.

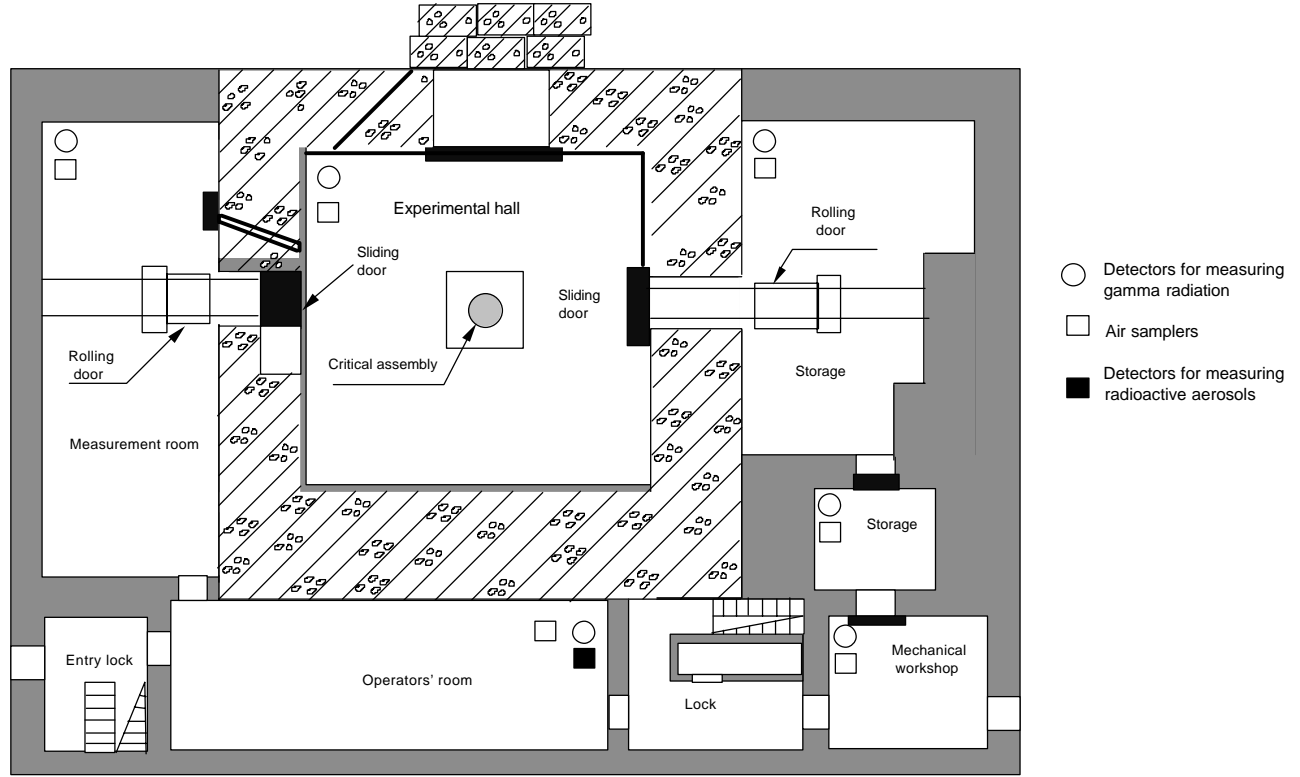

FIG. 3. Plan of the first floor of the building housing the critical assembly with the installed radiation monitoring systems.

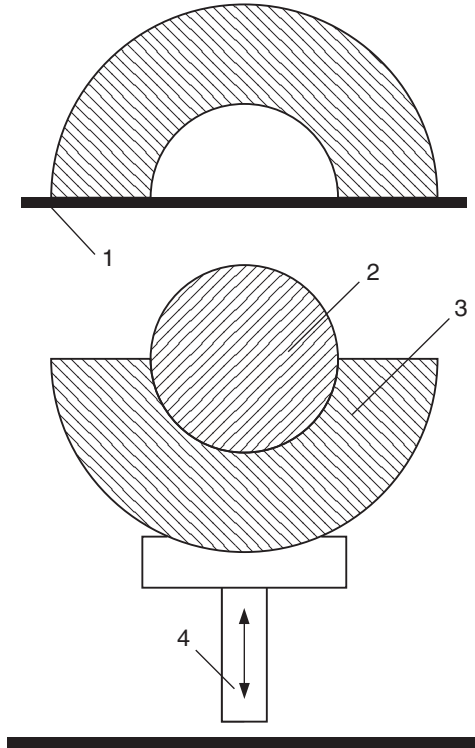

FIG. 4. Cross-section of the critical assembly (1: fixed upper reflector; 2: fissile material; 3: lower reflector; 4: raising mechanism).

Complete melting of the critical assembly would be expected to stop the chain reaction. Any serious criticality event would produce a powerful surge of neutron and gamma radiation, but the walls of the facility are designed to shield the technicians from the worst case power surge.

As mentioned earlier, the temperature of the assembly and the neutron and gamma fluxes are constantly monitored, and if preset levels are exceeded the system is automatically shutdown by the action of promptly lowering the lower part of the assembly to stop the chain reaction. Unfortunately, in the accident described in this report this automatic system did not actuate in sufficient time to prevent the overexposure of the technician, owing to the extremely short duration of the initial radiation pulse.

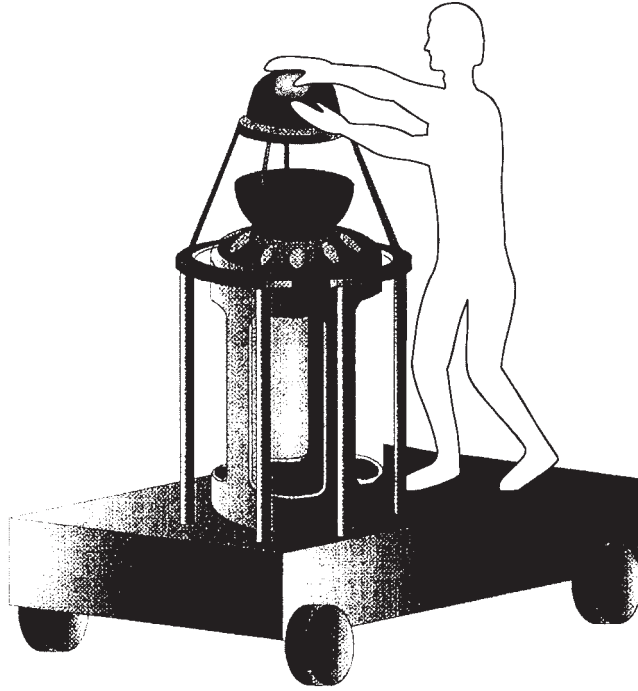

FIG. 5. Position of the operator at the time of the accident. Note: the beta–gamma neutron personal dosimeter was worn on the collar of the operator’s overall.

Regulatory and technical documents of the Russian Federation Ministry for Atomic Energy specify precisely the procedural and management requirements for work with critical assemblies. They require that this type of work be conducted only by groups of trained technicians, with each person being responsible for strictly defined actions within a sequence of operations which are closely supervised.

4. CIRCUMSTANCES OF THE ACCIDENT

On the morning of 17 June 1997 at about 09:30 a technician, a 41 year old male of height 1.80 m and weight 81 kg, reportedly started to assemble a previously functioning and familiar critical assembly comprising a high enriched uranium core and a predominantly copper reflector. The victim was an experienced technician who

had carried out several hundred previous criticality experiments. He was reportedly working with a well known system and was not expecting any problems. However, he was working alone in the experimental hall, which was a violation of documented procedures.

At 10:50, during the construction of the assembly, a component from the upper reflector slipped from the technician's rubber gloved hand and fell on to the lower part of the assembly, which had already been constructed and contained the enriched uranium core. (Gloves were routinely worn to prevent contamination of the components of the assembly.) The point of criticality was exceeded, there was a flash of light and a wave of heat, and the lower part of the assembly was ejected downwards into the bottom of the stand (Fig. 5).

The technician reportedly realized that a criticality accident had happened. He left the experimental hall and closed the sliding doors connecting the experimental hall to the adjoining rooms, as shown in Fig. 3. He informed his supervisors and colleagues of the event, reportedly telling them that he thought his exposure was likely to prove fatal.

During this first few minutes after the criticality event he was fully conscious and fully active. As soon as they were alerted, radiation protection personnel performed an initial direct radiological survey of the technician, which detected the neutron induced gamma radiation emitted by radionuclides in his body. Initial measurements indicated a whole body dose of about 10 Gy, which is well in excess of the level of 2 Gy which requires prompt action according to established emergency procedures, and his personal dosimeter was sent for immediate assessment.

The radiation emergency medical team was called, and the technician was sent to the local hospital at the occupational medical service.

5. RESPONSE TO THE ACCIDENT

The first task confronting the specialists arriving at the accident facility was to determine the status of the critical assembly and the probable consequences of the accident. The initial actions taken by the operators of the facility and radiation safety personnel are shown in Table I.

The response to the accident (Table I) reportedly corresponded closely to that specified in the emergency plans of the Russian Federal Nuclear Centre that were in place (Table II).

By 13:00 it had reportedly been firmly established there was no airborne or surface contamination within the experimental hall. However, the assembly was still in a state of criticality and was emitting significant amounts of neutron and gamma radiation. Of a number of neutron detectors used to measure the neutron flux in

TABLE I. INITIAL RESPONSE ACTIONS BY OPERATORS AND RADIATION PROTECTION PERSONNEL ON 17 JUNE 1997

| Time interval | Action taken |
|---------------|--|
| 10:50–10:52 | <ul style="list-style-type: none"> — Onset of the uncontrolled chain reaction: the overexposed technician leaves the experimental hall and closes the sliding doors. — Notification of the accident to the supervisor of experimental work in the facility and the head of the radiation safety group for the facility. |
| 10:53–10:55 | <ul style="list-style-type: none"> — Summoning of an ambulance and nurse from a first-aid post. — Arrival at the facility of the supervisor of experimental work and radiation safety staff, who was on duty nearby. — Initial assessment of radiation levels in the experimental hall and rooms adjacent to it. — Arrival of the head of the radiation safety group. |
| 10:56–10:59 | <ul style="list-style-type: none"> — Notification of the emergency monitoring unit and dispatch of personal dosimeter worn by the technician for assessment. — Closing of the door to the experimental hall (a large rolling concrete plug). — Initial assessment of the neutron dose received by the technician by gamma monitoring of induced ^{24}Na activity in his body. — Checking for possible exposure of other staff present in the facility at the time of the accident by monitoring of the rhodium neutron activation component of their personal dosimeters. — Notification of senior management on the site, including the site radiation safety department, of the occurrence of the accident. |
| 11:00–11:09 | <ul style="list-style-type: none"> — Evacuation of staff from the building in which the accident occurred. — Carrying out of a radiation survey outside the building. — Commencement of the processing of gamma thermoluminescent dosimeters (TLDs). — Filling out of an evacuation medical card for the technician. — Preparation for the arrival of the ambulance. |
| 11:10–11:20 | <ul style="list-style-type: none"> — Arrival of the nurse and medical first aid to the technician. — Commencement of processing of neutron dosimeters. |
| 11:21–11:25 | <ul style="list-style-type: none"> — Arrival of the ambulance and taking of the technician to hospital. |

normal operations in the room in which the accident occurred, all except the detector furthest from the assembly read off the scale. Another detector was introduced through a channel in the shielding to permit monitoring of changes in the neutron flux. By means of this detector, it was determined that the neutron flux was relatively stable, indicating that the chain reaction was self-regulating. A visual check of the

TABLE II. ACTIONS REQUIRED OF OPERATING STAFF AND RADIATION SAFETY PERSONNEL OF THE CRITICALITY FACILITY (AS SET OUT IN THE RUSSIAN FEDERAL NUCLEAR CENTRE EMERGENCY PLAN)

| Time elapsed since occurrence of accident (min) | Actions required |
|---|---|
| 0–2 | <ul style="list-style-type: none"> — Recognizing (detecting) the occurrence of the accident. — Preventing access to the danger area. — Summoning first aid. |
| 2–8 | <ul style="list-style-type: none"> — Checking list of staff to ensure that all are accounted for. — Rapid assessment of radiation doses received by staff. |
| 8–10 | <ul style="list-style-type: none"> — Notifying the management of the experimental facility of the accident. — Notifying the site radiation safety service of the accident. — Filling out the evacuation medical card for the technician. |
| 10–15 | <ul style="list-style-type: none"> — Provision of medical first aid to the technician. |
| 15–20 | <ul style="list-style-type: none"> — Dispatch of personal dosimeters for assessment by dosimetry personnel. |
| 40–70 | <ul style="list-style-type: none"> — Initial assessment of personal dosimeters. |

experimental hall was carried out using a periscope which allowed the emergency response team to take photographs from a door leading into the hall. These revealed that the critical assembly was located in the lower part of its stand and it was thus not possible to change the system's configuration by means of the normal control system.

To terminate the chain reaction it was necessary to remove remotely part of the critical assembly or to change its configuration in some other way. Personal access to the experimental hall was precluded owing to high radiation levels. The only option readily available to those dealing with the emergency was to use the remotely operated overhead crane in the experimental hall. A significant difficulty was the fact that moving any object close to the assembly would increase its reactivity and hence the heat and radiation generated by the system. In any method of dismantling the assembly, positioning any sizeable object near to it had to be avoided.

An ad hoc committee of specialists proposed and discussed a number of possible approaches to the problem. These included changing the configuration of the assembly remotely by mechanical or chemical means, by the use of a controlled explosion or by gas or plasma cutting. Promising ideas were investigated using specially designed models constructed in a nearby experimental facility in which

similar work with critical assemblies was being done. In parallel, separate calculations were made to model the effects of various actions on the system's criticality, including the likely effects on the generation of heat and radiation.

The first step taken was to remove from the experimental hall those containers of nuclear materials which had not been used in the construction of the assembly. The operation was conducted using a robot constructed by the Bauman University of Computer Engineering in Moscow (see Fig. 6).

Once this first stage was completed, specialists began remotely altering the configuration of the critical assembly. Using the robot manipulator, a thin walled conical vacuum suction device connected to a hose was suspended on the hook of the overhead crane. The suction device was then placed over the upper (copper) hemisphere covering the enriched uranium core. The movement of the critical assembly as this was done resulted in an approximately fourfold increase in neutron flux and an increase in temperature. Once the suction device was actuated and the configuration of the assembly altered, the chain reaction was stopped and the neutron output decreased as expected to the background level. The assembly was then removed using the crane and placed on to a stand for final dismantling at a later stage. The operation to make safe the critical assembly was concluded at about 01:20 on 24 June 1997.

6. DOSIMETRIC ANALYSIS

A full assessment of the dose received by the technician was carried out relatively quickly [24, 27]. This assessment included estimates of the dose the technician received in the initial burst of radiation and in the short period afterwards before he left the experimental hall. Subsequent radiation levels in the experimental hall were also estimated. A number of physical and biological methods were used in the estimation of the doses received and a simulation of the criticality event was carried out using calculational methods.

6.1. EVALUATION OF RADIATION FIELDS DURING THE CRITICALITY EVENT

The fission energy released at the moment of the critical reaction was estimated using readings obtained from the personal dosimeter worn on the left upper third of the chest. This registered a neutron dose (kerma) of 45 Gy and a gamma dose of 3.5 Gy. The number of fission reactions associated with the initial burst of radiation was 2×10^{16} , estimated on the basis of analysis of a fission track neutron dosimeter



FIG. 6. Robot manipulator (type MF-4).

(type DINA) using a ^{237}Np target. After the initial burst of radiation and the consequent displacement of the assembly, an effectively constant neutron flux of $4\text{--}5 \times 10^{13} \text{ s}^{-1}$ was measured through a counting channel with detectors in the hall. The temperature of the critical assembly varied between 200°C and 300°C (this was in accordance with the design value).

After the radiation burst at the initial criticality, radiation levels in the adjacent occupied rooms were found to be normal. Monitoring of neutron and gamma doses rates, as well as of airborne and surface contamination, showed no readings that were unexpected or were above the control values set by the Russian Federal Nuclear Centre. Neutron and gamma dose rates in the experimental hall in the period after the criticality event were estimated using a fission track neutron detector using a ^{237}Np target (type DINA) and IKS TLDs (see Fig. 7). Neutron and gamma dose rates measured at a distance of 3.5 m from the assembly were 2.3 Gy/h and 0.6 Gy/h, respectively.

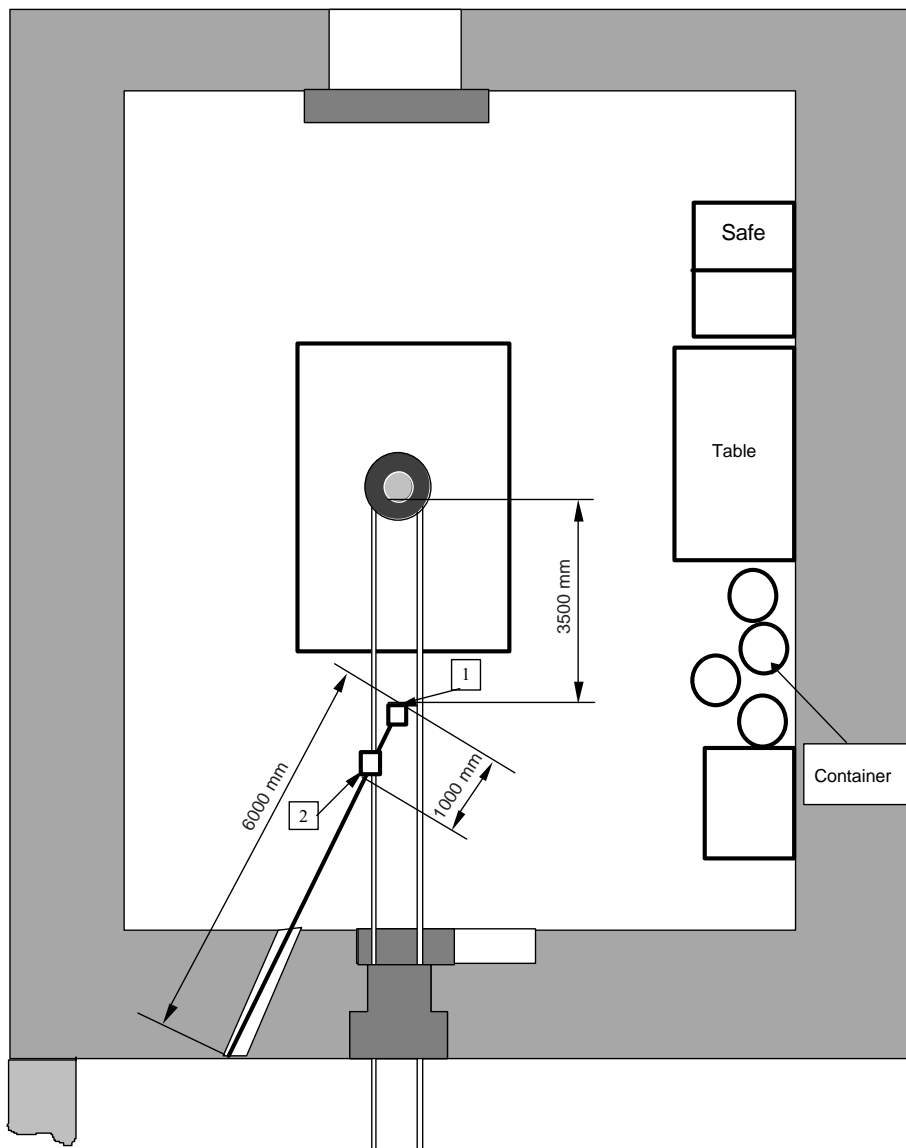

FIG. 7. Locations of dosimeters used for assessment of dose rates in the experimental hall. Note: measurement position No. 1—four detectors: a TLD, a track detector, an activation detector with nickel and an activation detector with indium. Measurement position No. 2—three detectors: a TLD, a track detector and an activation detector with indium.

6.2. DOSE ESTIMATES OBTAINED BY PHYSICAL MEANS

The Russian Federal Nuclear Centre employs a personal monitoring system [28] which is widely used at nuclear sites in the Russian Federation. It uses a combined beta–gamma neutron personal dosimeter (type GNEIS) comprising the following separate detector elements:

- A detector of rhodium activation by fast neutrons;
- For intermediate and fast neutrons, a fission track neutron dosimeter (type DINA) with a ^{237}Np target and aluminium in a boron filter;
- For assessment of beta and gamma doses, two IKS dosimeters with thermoluminescent detectors mounted in lead and aluminium filters to smooth out energy dependence.

At nuclear facilities in the Russian Federation there is a set of instructions to be used by radiation protection personnel in the event of a criticality accident. According to these instructions an initial assessment of the average neutron dose should be made by simple measurement of the gamma radiation emitted by neutron activation products in the body of an overexposed person. For the accident at Sarov, the value obtained in this way was approximately 10 Gy.

The position of the technician at the critical assembly at the time of the accident is shown in Fig. 5. The initial exposure was very non-uniform, with the highest doses expected to be to the hands and the upper part of the front of the body. Subsequent measurements and calculations were used to provide a much more complete picture of the dose distribution within the body.

6.2.1. Dose estimates obtained from the technician's personal dosimeter

Initial measurements with the rhodium (^{103}Rh) neutron activation detector as well as observation of activation of the aluminium filter in the IKS TLD indicated a dose due to fast neutrons of about 50 Gy.

The accuracy of the estimated dose due to fast neutrons was later improved by using data from the neptunium fission track dosimeter. This indicated an estimated dose (kerma) of 45 ± 5 Gy, corresponding to a neutron flux on the surface of the upper third of the chest, where the dosimeter was worn, of about $(1.8 \pm 0.2) \times 10^{12} \text{ cm}^{-2}$.

The gamma dose measured by the IKS TLD was 3.5 ± 0.3 Gy, this being obtained by averaging the results for both TLD elements in the detector.

On the basis of these results, and supposing that the technician's hands were 10 cm away from the assembly, the estimated dose to his hands was about 250 Gy.

6.2.2. Dose estimates obtained using activated biological materials

The initial estimate of the average whole body neutron dose determined at Sarov by measurement of induced activity in the technician's body was 8–11 Gy.

He was transferred to the Institute of Biophysics of the Ministry of Health in Moscow at 21:00 on the day of the accident. Upon arrival in Moscow, his activity was directly measured using a radiation monitor, which showed a rather non-uniform distribution of induced gamma activity within the body. For example, dose rates were 30 $\mu\text{Gy/h}$ at the head, 45 $\mu\text{Gy/h}$ over the chest, 35–40 $\mu\text{Gy/h}$ over the abdomen and 17–19 $\mu\text{Gy/h}$ for the left leg. The non-uniform dose distribution was confirmed by the first dosimetry results, which became available early in the morning on the day after the accident (18 June 1997). These included the result of 3.5 Gy for the gamma dose received by the TLD component of the technician's personal dosimeter. (It was already recognized that the neutron dose would be much higher.) At this stage the absorbed gamma dose to the hands was estimated to be between 200 and 300 Gy.

On admission to hospital in Moscow and again on the following morning (21 h after the accident), blood samples were taken for assessment of induced ^{24}Na activity. The activity concentrations in these samples were 290 Bq/mL and 260 Bq/mL, respectively, which correspond to a mean whole body neutron dose of about 14 Gy. Samples of hair were taken from various parts of the body (the front and back of the head and the armpits and pubic area) for dose assessment on the basis of the ^{32}S (n, p) ^{32}P reaction. The results were available only after the technician's death.

A summary of the results of the various measurements and calculations of doses is presented in Table III.

6.2.3. Dose estimates obtained by calculation of whole body dose and dose distribution in the body

In the Monte Carlo Study Group of the Mathematical Department of the Russian Federal Nuclear Centre the neutron and gamma emission spectra for the experimental critical assembly were calculated and used to predict the distribution of dose throughout the body of the overexposed technician. Calculations were carried out using the program C-90, which models the joint transport of neutrons and photons.

This mathematical modelling and simulation were based on standard established procedures outlined in written guidance for post-accident responses and adapted to meet the particular circumstances of this accident. The intensities of the neutron and gamma fields around a critical assembly are usually characterized by the energy and spatial distribution of neutrons and photons, and the neutron and photon fluxes. These characterizations were made and from them the neutron kerma (in body tissues) and the absorbed dose for gamma radiation were derived.

TABLE III. SUMMARY OF DOSE ASSESSMENTS BY MEASUREMENT AND CALCULATION

| Location | Neutron radiation | | Gamma radiation | |
|-----------------|-------------------|---|--------------------|-------------------|
| | Kerma (Gy) | Method | Absorbed dose (Gy) | Method |
| Face | 41 ± 12 | ³² S (n, p) ³² P | 4.5 | Measurement (ESR) |
| | | | 5.4 | |
| | | | | Calculation |
| Back of head | 13 ± 4 | ³² S (n, p) ³² P | — | — |
| Left armpit | 43 ± 13 | ³² S (n, p) ³² P | — | — |
| Right armpit | 60 ± 18 | ³² S (n, p) ³² P | — | — |
| Pubic area | 29 ± 9 | ³² S (n, p) ³² P | 3 | Calculation |
| Chest | 45 ± 5 | Measurement (type DINA) | 3.5 ± 0.3 | Measurement (IKS) |
| | | Calculation | 2.5 ± 0.5 | Calculation |
| Back | 6.7 | Calculation | 4.1 | Calculation |
| Hands | 1500 ± 320 | Measurement (ESR) | 100 ± 5 | Measurement |
| | | Calculation | 120 ± 12 | Calculation |
| | 8–11 | ²³ Na (n, γ) ²⁴ Na (rapid method) | | |
| Average to body | 14 ± 4 | ²³ Na (n, γ) ²⁴ Na (spectrometry) | 3.5 ± 0.3 | Measurement (IKS) |

The Monte Carlo method can predict the spectra of neutrons and gamma radiation emerging from the critical assembly quite accurately (with a statistical error of no more than 2%). The predicted spectra for this accident are shown in Figs 8 and 9. (Calculated values have been normalized to one fission in the active zone of the critical assembly.)

The Monte Carlo method was also used to predict the spectral characteristics of neutrons and doses near the surface of the body, including the vicinity of the technician's personal dosimeter. The spectrum of neutrons striking different points of the technician's body surface was determined from the neutron spectrum emitted

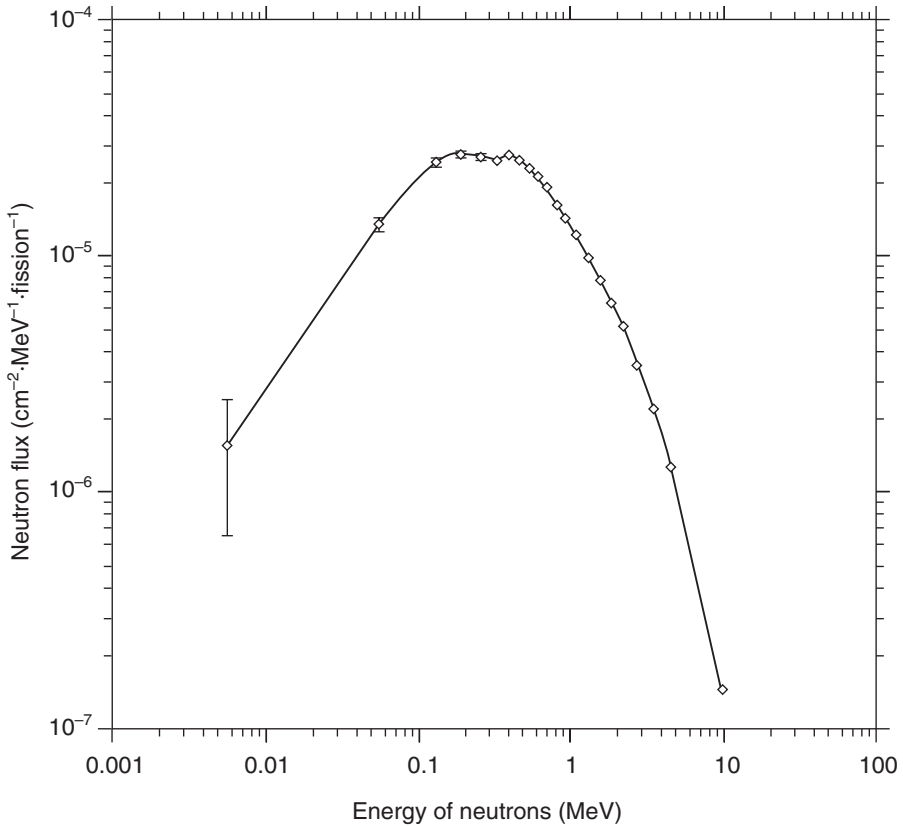

FIG. 8. Calculated neutron energy spectrum.

from the assembly, modified to allow for the spectrum of neutrons reflected from the body of the worker (the albedo effect). Anthropometric data for the technician were included in these calculations. The distance from the centre of the surface of the thorax to the centre of the critical assembly was assumed to be 53 cm. The effect of induced gamma emitting activity in the body and in the personal dosimeter components was taken into account in the calculations.

The results made it possible to estimate the fission energy released in the initial criticality event. On the basis of this work and the assumptions mentioned earlier concerning the position of the technician at the time of the initial radiation burst, the average dose to the upper part of the body was estimated to be 40 ± 1 Gy for the neutron component and 2.5 ± 0.5 Gy for the gamma component.

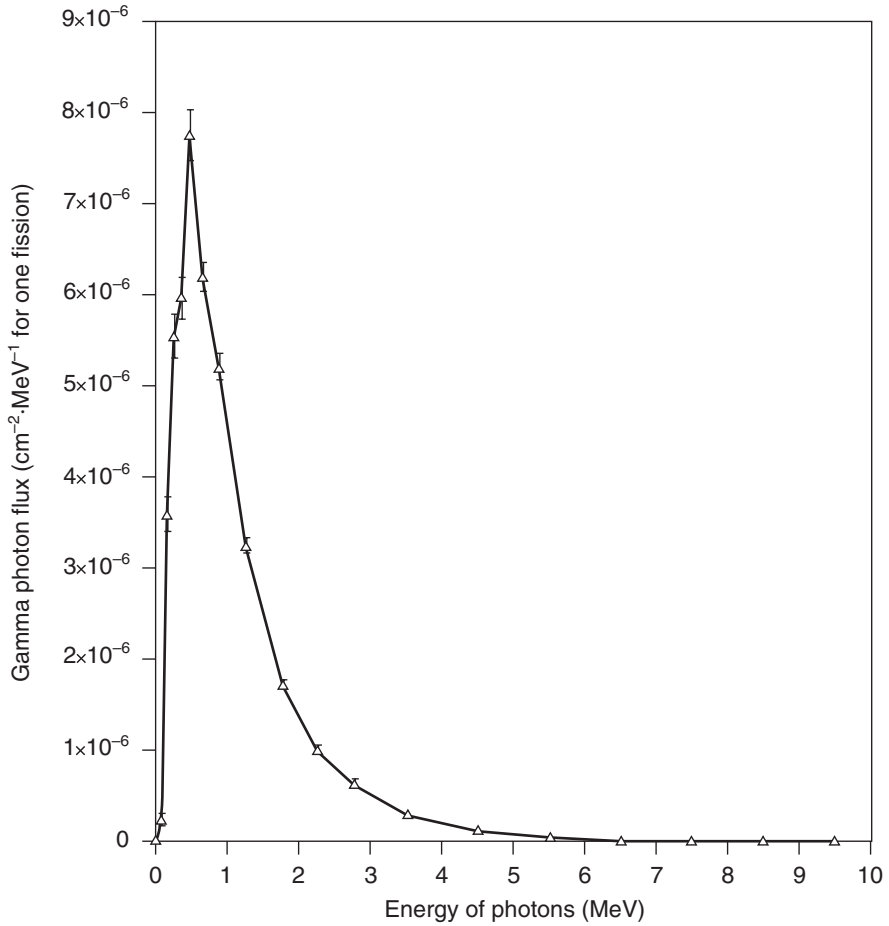

FIG. 9. Calculated gamma radiation spectrum.

Irradiation of different parts of the technician's body surface was very inhomogeneous, being highest in the area of the hands. The technician estimated the distance of his hands to the surface of the critical assembly as about 5 cm and calculations were made for distances ranging from 1 to 5 cm, treating the hands as a standard soft tissue with a density of 1 g/cm³. This suggested that the total dose to the hands could lie between 800 and 2000 Gy. The final estimates were 1700 ± 170 Gy and about 120 Gy for the neutron and gamma components, respectively.

Similar calculations were made for other parts of body surfaces and, using methods described elsewhere [29], the distribution of doses by depth was calculated. Complete calculations were carried out for the regions of the chest and head, and the results of these are shown in Table IV.

6.3. DOSE ESTIMATES OBTAINED BY BIOLOGICAL DOSIMETRY

Two methods were used for the assessment of doses by biological dosimetry, one on the basis of haematological findings and the other on cytological investigations. The advantage of the first method is its speed. On the basis of the absolute lymphocyte count, the dose could be estimated from analyses performed one hour, three hours and six hours after exposure [13, 30]. The reference curves used in this assessment [31] are shown in Fig. 10.

Chromosome aberration analysis, an established method for assessing mean whole body dose, uses the technician's own biological material as a dosimeter [32]. This method takes time, since the lymphocytes need to be cultured. Currently, the minimum time period between sampling and results cannot be reduced to less than three days. Moreover, in the case of non-uniform exposure, the technique can only give some hypothetical mean dose, and the reliability of the method was limited by the too high dose. If the whole body dose exceeds about 10 Gy, it is difficult to perform the analysis because there are few if any viable cells that can be cultured.

Immediately after the accident, blood samples were taken for lymphocyte counting. The results showed that the exposure had been severe, with lymphopenia increasing quickly with time: $0.9 \times 10^9 \text{ L}^{-1}$ at 1 h, $0.6 \times 10^9 \text{ L}^{-1}$ at 3 h, and $0.18 \times 10^9 \text{ L}^{-1}$ at 5 h. Samples taken 47 h after exposure showed a complete absence of circulating lymphocytes. Comparison of these data with the reference chart (Fig. 10) indicated a dose higher than 12 Gy. This indicated an extremely poor prognosis with most probably a fatal outcome.

Chromosome aberration analysis could not be performed on circulating blood lymphocytes because of the deep lymphopenia (significant decrease of the number of lymphocytes in peripheral blood) at the time of sampling. In addition, the surviving lymphocytes were damaged, which made culturing of these cells difficult if not impossible and made any results obtained unreliable. Therefore, bone marrow cells were used for assessing chromosome aberrations by a direct method that does not require cell culturing.

Samples of bone marrow were taken from four places: the sternum, the left anterior iliac crest, the right posterior iliac crest and the fourth thoracic vertebra. Although more complicated and painful for the patient, this approach has the advantage of giving a clearer picture of the spatial dose distribution, which may be important for decisions on medical treatment.

TABLE IV. DISTRIBUTION OF DOSES BY DEPTH (10^{-12} Gy·cm⁻²·neutron⁻¹)

| Location and type of dose | | Depth (cm) | | | | | | |
|----------------------------|---------|------------|------|------|------|-----|-----|------|
| | | 0 | 2 | 4 | 8 | 14 | 20 | 21 |
| Chest — front to back | Total | 29.5 | 26.4 | 21.5 | 13.6 | 5.9 | 3.7 | — |
| | Gamma | 3.3 | 3.8 | 4.6 | 4.4 | 2.9 | 2.3 | — |
| | Neutron | 26.2 | 22.6 | 16.9 | 9.2 | 3.0 | 1.4 | — |
| Head — forehead to back | Total | 28.1 | 23.0 | 17.1 | 9.9 | 4.4 | — | 1.7 |
| | Gamma | 2.8 | 3.1 | 3.7 | 3.5 | 2.3 | — | 1.7 |
| | Neutron | 25.3 | 19.9 | 13.4 | 6.4 | 2.1 | — | <0.1 |

Note: Doses are normalized to a flux of one neutron per square centimetre incident on the body.

The following doses were estimated for the areas of the skeleton explored:

- At least 15 Gy to the sternum (no metaphases seen, damaged chromosomes and several structures with fully fragmented chromosomes);
- 10–15 Gy to the left anterior iliac crest (on the basis of an analysis of 12 metaphases, half of which had aberrations and the remainder of which had fragmented chromosomes);
- 6–7 Gy to the right posterior iliac crest (on the basis of 50 metaphases, of which 48 had multiple aberrations and two had fragmented chromosomes);
- About 6 Gy to the fourth thoracic vertebra (on the basis of three metaphases, of which two had fragmented chromosomes).

These results indicated that the dose received was very high and was non-uniformly distributed. They confirmed the haematological findings and the results of the calculational dose assessments, especially with regard to the non-uniform dose distribution.

6.4. DOSE ESTIMATES OBTAINED BY RETROSPECTIVE DOSIMETRY

Electron spin resonance (ESR) can be used to estimate doses in some biological materials such as tooth enamel and bone and in clothing materials [12, 26]. The technician's clothing would have been particularly suitable for estimating the spatial distribution of the dose since they were related to his position, orientation and

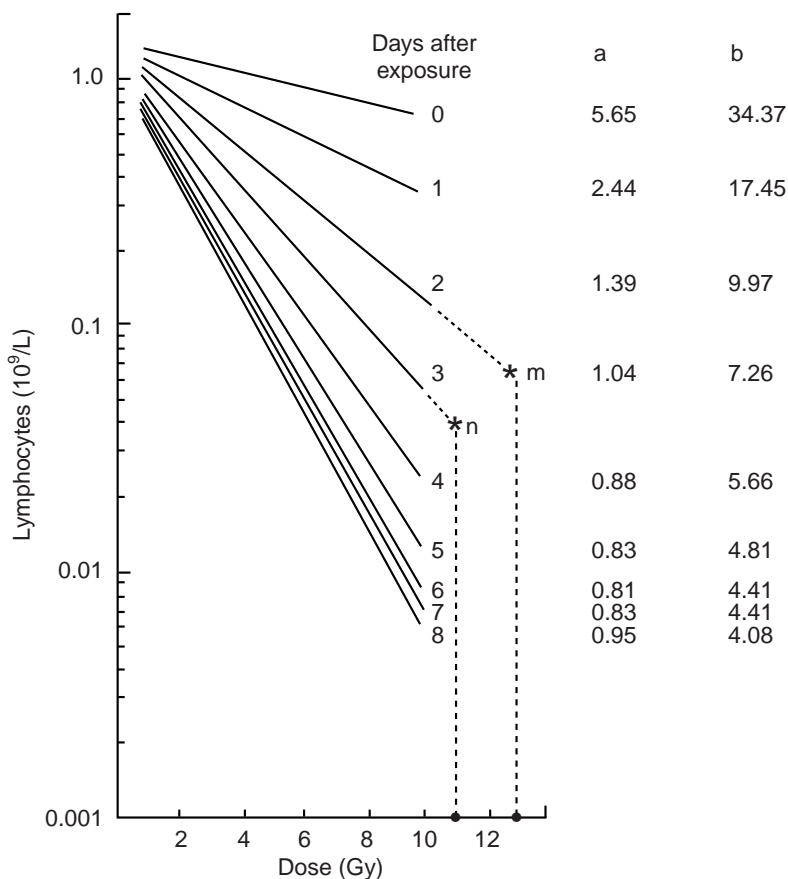

FIG. 10. Reference chart for dose assessment using lymphocyte counting [13, 31].
 Note: $dose = a - [b \times \log(\text{lymphocyte counts})]$.

movement. This method has been successfully used for dosimetry following several accidents [12, 13]. Unfortunately, in this case the technician's clothes were misplaced after the accident and, consequently, no studies could be performed on them. It was only after the patient's death that ESR analysis could be performed on samples of tooth enamel and of bone taken from the fingers of the hand. The ESR signal from tooth enamel (taken as representative of the dose to the face) corresponded to a dose of 5.7 ± 0.5 Gy. Approximately 20% of this signal was attributed to the neutron component. This is lower than the actual percentage of total dose for the neutron dose because the sensitivity of the ESR method for the neutron dose is only about 3% of that for the gamma dose [33]. The results of the ESR investigation of the bone taken from the fingers are shown in Table III.

7. MEDICAL TREATMENT OF THE PATIENT

7.1. INTRODUCTION

Fatal accidents caused by high doses of ionizing radiation are rare [34], and of those that have occurred only a small proportion have been caused by predominantly neutron exposure, which makes the accident at Sarov of great scientific interest. The medical management of the patient did not give rise to problems, since the accident had been immediately recognized and the medical response was reportedly promptly initiated. The likely fatal outcome was reported to be foreseen early on despite the appropriate medical treatment being provided in a timely fashion.

7.2. MEDICAL RESPONSE AT SAROV

The technician arrived at the Sarov occupational medical service at 11:45 on 17 June 1997, slightly less than one hour after the accident, and was immediately examined. At this stage he was experiencing nausea and he began to vomit, with vomiting increasing in frequency over the following two hours. He was treated with antiemetic drugs, and vomiting stopped at around 14:00.

At the clinic of the occupational medical service, the severity of his exposure was clinically evaluated and some symptomatic treatment provided. His general condition was already poor, and he was experiencing fatigue, dizziness and headache. He showed paleness and excessive perspiration. His hands showed a rapidly invasive erythema (skin reddening). His blood pressure was 90/50 mm Hg, pulse 104/min and body temperature normal. It was known from previous health surveillance records that the individual was hypotonic, with a low blood pressure of 90/60 mm Hg.

A summary of haematological findings is presented in Table V. As soon as the technician arrived at the clinic of the occupational medical service, a blood sample was taken, and this showed that (one hour after the accident) there was already a tendency towards lymphopenia. This became more evident in a further blood sample taken an hour later (two hours after exposure). In addition to antiemetic drugs (metoclopramide hydrochloride and atropine), the patient received detoxifying agents (infusions of polyvidone 6% and glucose 5%) and prednisolone (90 mg).

Both the general state of health of the patient and his localized injuries deteriorated rapidly. As blood pressure was slightly depressed (80/40 mm Hg), he was treated with phenylephrine (10 mg). This resulted in the blood pressure increasing temporarily to 100/60 mm Hg. In the early afternoon the blood pressure no longer

responded to the treatment, dropping to 80/60 mm Hg and then 70/50 mm Hg. Hyperaemia (excessive blood flow) developed on the chest and the body temperature started to rise (37.8°C at 14:00). The patient became confused and complained of weakness and headache. He exhibited continuous shivering, in spite of a fairly normal body temperature. He was given dopamine (200 mg by infusion). He did not demonstrate any episodes of diarrhoea. His hand injuries worsened rapidly: the erythema progressed and was accompanied by oedema (swelling), which became invasive within a few hours.

Monitoring of the patient for contamination at 15:30 showed that he was not externally contaminated, but the observation of neutron induced gamma activity in the body, the symptoms seen so far and the description of the accident all indicated a very high dose with a very poor prognosis. Accordingly, it was decided to send the patient to a specialized hospital, and he was transferred by air to Moscow. He arrived in the Clinical Department of the Institute of Biophysics in the Ministry of Health at 20:50 on the day of the accident, ten hours after his exposure.

7.3. SPECIALIZED HOSPITAL TREATMENT IN MOSCOW

On admission to hospital in the Clinical Department of the Institute of Biophysics in the Ministry of Health at 21:00 on the day of the accident, ten hours after exposure, the patient was placed in an isolated room assigned to patients exposed in radiation accidents. He was still active, could move by himself and was stable in a vertical position. He was fully conscious but fatigue and headache were persistent. He mentioned a slight pain in the area of the parotid glands which was made worse by swallowing and palpation. His blood pressure was 90/70 mm Hg (which was an improvement over that when he left Sarov) and his pulse was stable at around 100/min.

The hands showed rapid deterioration with pronounced erythema and oedema. He reported an unpleasant feeling of heaviness in his hands. His eyelids were swollen with conjunctivitis. There was a moderate erythema affecting the face and chest.

At 23:00, two hours after admission, a full physical examination was undertaken. A specialized neurological examination and an electroencephalogram (EEG) examination did not detect any effects. Ultrasound examination of abdominal organs showed moderate hepatomegalia and splenomegalia (enlargement of the liver and spleen, respectively). In addition, these organs exhibited dilation of the small blood vessels, which was not apparent in the head and neck region. Doppler ultrasound scanning showed a significant increase of blood flow in the hands, which was more pronounced on the left (thumb) side of the right hand. Blood flow in the face and chest was also increased.

TABLE V. CHANGES IN HAEMATOLOGICAL PARAMETERS WITH TIME

| Date | Time | Hb (g/L) | Erythro- cytes | SR (mm/h) | Reticulocytes (‰) | Thrombocytes ($\times 10^9/L$) | WBC ($\times 10^9/L$) | Neutrophils | | Lymphocytes | | Monocytes (%) | |
|--------------|-------|-------------|-------------------|--------------|----------------------|-------------------------------------|----------------------------|-------------|-------------------------|-------------------------|------|------------------|-----|
| | | | | | | | | Band (%) | (%) ($\times 10^9/L$) | (%) ($\times 10^9/L$) | (%) | | |
| 17 June 1997 | 12:00 | | | | | | 4.5 | | 69 | 3.1 | 23.0 | 0.9 | |
| | 14:00 | | | | | | 15.0 | | 95 | 14.3 | 4.0 | 0.6 | |
| | 16:00 | | | | | | 9.0 | | 96 | 8.6 | 2.0 | 0.2 | |
| | 21:10 | 160 | 5.6 | 15 | 7 | 314 | 15.0 | 17.0 | 73.0 | 11.5 | 4.0 | 0.5 | 5 |
| | 22:10 | 134 | 5.0 | 22 | 5 | 300 | 12.1 | 27.5 | 67.5 | 11.5 | 0.5 | 0.1 | 4.5 |
| 18 June 1997 | 00:15 | 140 | 5.1 | 16 | 12 | 321 | 13.5 | 28.0 | 66.5 | 12.7 | 1.0 | 0.1 | 4.5 |
| | 03:00 | 135 | 4.9 | 14 | 8 | 302 | 12.2 | 17.0 | 79.5 | 11.7 | 1.5 | 0.2 | 2 |
| | 06:15 | 133 | 5.1 | 17 | 3 | 321 | 10.9 | 18.5 | 75.5 | 10.2 | 2.0 | 0.2 | 3 |
| | 09:35 | 160 | 5.6 | 15 | 7 | 314 | 15.0 | 31 | 64.5 | 14.3 | 2.0 | 0.2 | 2 |
| 19 June 1997 | 9:35 | 201 | 7.1 | — | 11 | 482 | 12.0 | 17.5 | 80.5 | 11.7 | 2.0 | 0.2 | 2 |

Note: Accident occurred at 10:50 on 17 June 1997; Hb: haemoglobin; SR: erythrocyte sedimentation rate; WBC: total white blood cells.

Two blood counts were performed soon after admission to the hospital in Moscow, at 21:10 and 22:10. They showed absolute leucocytosis with successive results of $15 \times 10^9 \text{ L}^{-1}$ and $12.1 \times 10^9 \text{ L}^{-1}$ for white blood cells, but reduced numbers of lymphocytes at $0.5 \times 10^9 \text{ L}^{-1}$ and $0.1 \times 10^9 \text{ L}^{-1}$ (see Table V).

On the basis of the available information, the situation was severe, although bone marrow depletion might not have been irreversible since the non-uniform exposure meant that some bone marrow might have remained viable. It was clear that the hand injuries were severe and would need radical surgical intervention.

It was decided that for the time being bone marrow transplantation should not be considered. Haematopoietic growth factor therapy was considered and steps were taken to make it available. Urgent treatment was necessary to deal with the likely secondary consequences of the localized injuries to the hands, including bacterial and viral infection, intoxication and intravascular coagulation. Treatment to prevent infection included the following: irrigation of both hands with Lioxazol, a special drug developed by the pharmaceutical laboratory of the Institute of Biophysics (administered once every one to two hours); continuous perfusion of sodium heparin (20 000 IU (international units)/d) with plasma infusion and acyclovir (6 mg/kg of body weight over 8 h); ketoconazole (200 mg twice a day); and ciprofloxacin (250 mg twice a day). An antinecrotic drug, aprotinin (1 million IU/d), was also prescribed as a precaution.

On the first night (17–18 June) the swelling of the hands continued to worsen and the patient said that the pain became intolerable. Swelling extended to the forearms and the erythema in these areas darkened. In contrast, the erythema on the face and chest exhibited a return to normal skin colour, and the earlier swelling of the parotid glands was reduced.

On the morning of the second day (18 June 1997) the patient's general state was evaluated as critical. Further tests were undertaken and more information became available to allow a more precise clinical evaluation:

- An X radiography examination of the chest (at 11:00) showed a modified lung aspect, more marked in the upper right lobe, with interstitial infiltration, as well as an interlobular pleura. There was a suggestion of interstitial oedema.
- Bone marrow aspirates were performed for chromosome aberration analysis in the sternum, the left anterior iliac crest, the right posterior iliac crest and the fourth thoracic vertebra, and two bone marrow biopsies were taken for morphological assessment.
- Dose measurements from the ^{237}Np fission track neutron dosimeter were available from Sarov at 11:45. (The neutron dose was reported to be 45 Gy.)

The hand injuries continued to worsen, with spreading of the erythema and swelling over more areas of the forearms. Multiple foci of wet desquamation appeared on both hands. The peripheral catheterization was replaced by a central one located in the right femoral vein. At the end of the second day a second wave of erythema and oedema appeared on the upper arms, chest and neck.

On the day after the accident (18 June 1997) blood pressure remained low at 80/60 mm Hg. The first signs of oliguria appeared, despite the volume of liquids infused (1500 mL) and the administration of furosemide. The urine volume for the first 12 h after admission to the clinic in the Institute of Biophysics in Moscow was only 800 mL, and the patient had no voiding between 12:00 and 18:00 on the second day. Because of the drop in pressure in the femoral vein, steroids were urgently administered. Methylprednisolone (125 mg, once) and dexamethasone (8 mg/8 h) were administered and the volume of infused fluids was increased to 200 mL/h. Oliguria persisted and indeed worsened, and fluid infusion was reduced to 100 mL/h. The total volume of fluid infused on the second day was 2800 mL, compared with a urinary output over the same period of 1200 mL. On the morning of the second day the patient produced a stool of normal consistency. The only intestinal symptom was pain on palpation of the abdomen.

On the third day there was a dramatic deterioration in the patient's condition. In the early morning auscultation revealed bubbling sounds in the upper axillary part of the right lung, and pleural friction. The pulse rate remained constant at around 100/min, while an electrocardiogram (ECG) showed a diminished conductivity (incomplete blockage of the first degree with $PQ = 0.2$).

The preliminary results from the bone marrow investigation were available on the morning of the third day. The four myelograms could be classified into two groups:

- Very severe chromosomal damage in the samples taken from the sternum and left anterior iliac crest, corresponding to bone marrow doses estimated as approximately 8–12 Gy;
- Moderate changes in the samples removed from the fourth thoracic vertebra and right posterior iliac crest, corresponding to doses in the range of 4–6 Gy.

These were the preliminary dose estimates: the final results are given in Section 6 of this report.

Vascular disorders were found locally. Blood flow rates were below normal and reached a critical level, suggesting the onset of gangrene in the superficial layers of tissue of the hands and forearms. This correlated with the occurrence on the morning of the third day of several blisters on the palms of the hands as well as extensive spreading of the oedema to the upper parts of the arms (see Fig. 11). Some white foci appeared within the large dark brown areas on the skin. Swelling increased in the

areas of the chest, face and neck (see Fig. 12). There were obvious symptoms of mucositis in the mouth. ECG and ultrasound examination of the heart showed changes in the myocardium as well as some signs of ischaemic disorder.

In the clinical examination on the third day examination of the lungs by X radiography and computed tomography (CT) showed a progressive interstitial oedema and leaking of fluid into the pleural spaces. The first X radiography examination, performed at 09:00, showed a slight interstitial oedema without any fluid in the pleurae. However, a CT examination made at 14:00 revealed fluid in both lungs (1200 mL in the left and 2000 mL in the right) as well as fluid in the pericardial space (200 mL) (see Fig. 13).

An ophthalmological examination demonstrated reduced pressure in the central artery of the retina and this, combined with the conjunctivitis, seemed consistent with a significant radiation dose to the front of the head.



FIG. 11. Left palm of the victim 50 h after exposure.



FIG. 12. Edematous face and thorax of the victim 50 h after exposure.

At this stage, following a discussion among the medical specialists treating the patient which concluded that the various injuries were life threatening, it was decided that amputation of both arms was necessary in order to save his life. Accordingly, the infusion of sodium heparine, aprotinin and acyclovir was discontinued and blood flow was improved by the administration of Rheopolyglucine. Amputation of both arms was performed at about 16:20 on 19 June 1997 under endotracheal narcosis. The left arm was amputated at mid-humerus level and the right arm at the upper humerus. After the operation the patient was placed in the intensive care unit and artificially ventilated.

For the first few hours after the operation the patient's general state remained stable, with a pulse of 100–104/min and blood pressure between 80/50 and

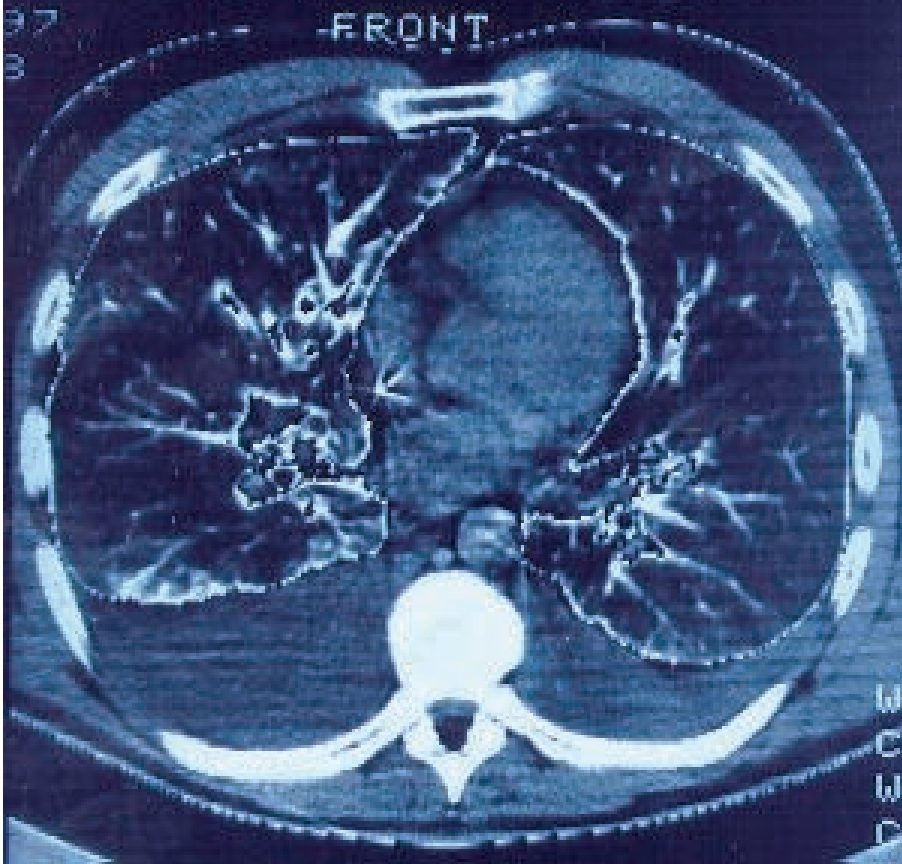

FIG. 13. Computer tomographic image of the thorax at the level of Th-10. Note compression of the lung by pleural fluid and intensification of the lung pattern.

105/60 mm Hg. Cardiac support with dopamine was continued. Injections of furosemide (80 mg followed by 160 mg) resulted in successive voidings of 850 mL and 450 mL. Management of blood concentration (thickening) became an issue because of the increase of the central venous pressure (to 20 cm of water column compared with the normal value of 16 cm). Cell counts showed 7×10^{12} erythrocytes/mL and creatinine levels up to 295 $\mu\text{mol/L}$. The decision was taken to continue fluid infusion under diuresis control, restricting the volume infused to 1 L/h. From 20:00 treatment included dopamine at 4 mg/h and (over a period of 6 h) albumin 20% (200 mL), sodium 4% (100 mL) and plasma (1000 mL). There was a dramatic drop in the blood albumin level on the third day, the concentration falling

from 35 g/L (normal level) at 09:00 to 19 g/L at 19:00. This provided indirect proof of severe fluid leakage within the body.

At 02:45 on the next day (20 June 1997) the blood pressure dropped dramatically and bradycardia developed. At 03:20 in the morning, 66.5 hours after exposure, the patient died. The apparent cause of death was heart failure.

8. FINDINGS OF THE POST-MORTEM INVESTIGATION (AUTOPSY)

8.1. INTERNAL ORGANS

8.1.1. Brain

- Widespread oedema was observed, with blood vessels dilated and filled with blood.
- An increased number of drainage glial cells and moderate enlargement of astrocytes were observed.

8.1.2. Bone marrow

- Blood circulation was disrupted with haemorrhaging and oedema in bone marrow samples taken from the anterior and posterior parts of the skeleton.
- There was severe aplasia without any evolving cells of haematopoiesis in the bone marrow taken from the front of the body. Practically all the parenchyma was replaced by red blood cells, with only a few islands where mature granulocytes and stromal cells could be identified. Megakaryocytes were absent.
- Bone marrow from the back of the body showed very mild and localized hypoplasia. The ratio between the volumes of the haematopoietic and fat tissues was about one to one. Cytological findings were of a reduction in numbers of all forms of evolving red blood cells and granulocytes, an increased number of plasmocytes and a normal number of megakaryocytes. Significant numbers of dead cells were observed everywhere (see Fig. 14).

8.1.3. Spleen

The spleen had a significantly damaged structure. Blood vessels were dilated and full of blood and there was extensive haemorrhaging. Very few lymphocytes, stroma cells and macrophages could be seen in the red pulp.

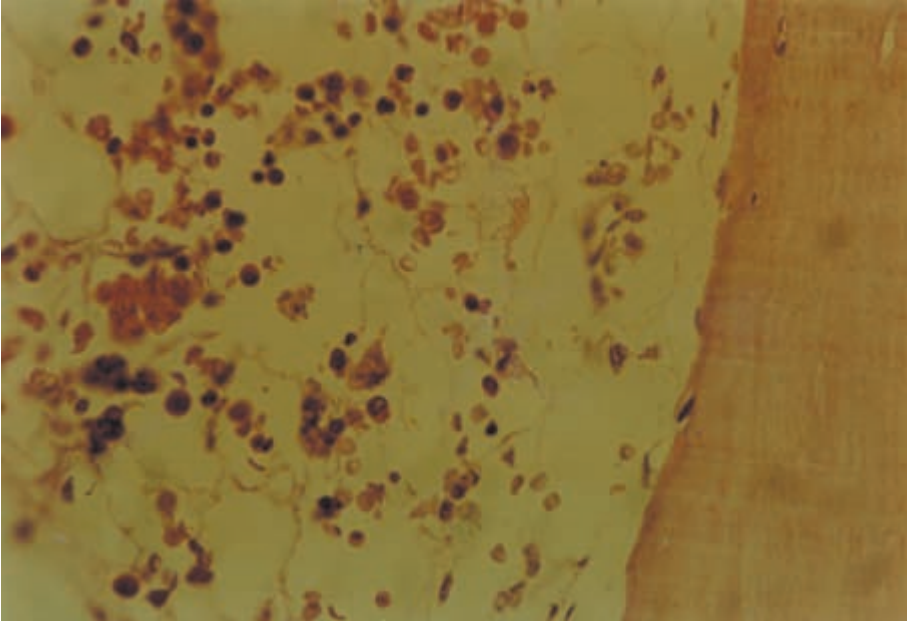

FIG. 14. Aplastic bone marrow with a few islands of mature granulocytes.

8.1.4. Liver

- Blood circulation was obviously disrupted, with some vessels dilated but empty. In the central sinuses of most hepatic lobules the blood vessels were dilated and full of blood.
- Generally there was a normal lobular structure, with some areas of damage and evidence of dead hepatocytes.

8.1.5. Kidneys

- There was obvious vascular disruption, with vessels in the interstitium dilated and full of blood.
- There were enlarged glomeruli, with dilated capillaries and widespread necrosis of the epithelial cells everywhere.
- There was obvious oedema in the renal pyramids.

8.1.6. Stomach and small and large intestines

- There was oedema in the walls of the gut, with vessels in the submucosal layer dilated and full of blood.

- There was dystrophy and necrosis of the epithelial cells.
- Some areas of complete denudation were observed in the wall of the small and large intestines.
- There was lymphoid cellular infiltration in some areas of the submucosal layer in the small intestine.

8.1.7. Heart

- Obvious interstitial oedema was observed.
- Most vessels were full of blood.
- There was some variation in the size and form of the nuclei in cardiomyocytes.
- There was approximately 200 mL of bright yellow fluid in the pericardial space.

8.1.8. Lungs

- General and extensive interstitial oedema was observed, with some blood vessels dilated.
- There were multiple haemorrhages and hydrothorax on both sides.
- Atelectases (collapsed alveoli) and ruptured interalveolar septa were observed.

8.1.9. Testes

- Interstitial oedema was observed, with blood vessels dilated.
- Destruction of the spermatogenic epithelium and absence of mature spermatozoa were observed.

8.2. ARMS AFTER AMPUTATION

Tissue samples taken from the point of amputation of the arms revealed oedema of the dermis and pronounced oedema affecting the intermuscular spaces. Some apoptotic cells were found in the basal layer of the epidermis. There were groups of migrating cells in the superficial upper layers of the dermis.

Skin samples from the inner surface of the right forearm showed oedema in the dermis, with damage to its normal structure. The dermal papillae were flattened or in some areas absent. Oedema in the muscular tissue was much more pronounced than at the amputation site. There were accumulations of erythrocytes in blood vessels of all sizes.

On the palm of the right hand the keratin layer was very thick. Almost all cells in the epidermis were dead except for a few found in the basal layer. There was oedema of the dermis, with complete destruction of its structures. Oedema in the muscle tissues was very pronounced. Blood vessels were dilated and full of blood.

In the area of the blistering on the skin of the fingers of the right hand the epidermis was detached and its layers were disorganized. There were a few areas where stem cells were preserved but these had dystrophic nuclei. There was oedema of the dermis, with its structure completely destroyed. Some blood vessels were in spasm, others dilated.

In the area of the blistering on the palm of the left hand the epidermis was detached and the cells in all its layers were dead. There was oedema of the dermis, with destruction of its layers and degeneration and partial destruction of the sweat glands. Blood vessels in the dermis were dilated and full of erythrocytes. The hypodermis and muscle tissues exhibited oedema, with blood vessels dilated and full of blood.

In the area of the blistering on the fingers of the left hand there was detachment of the (thick) epidermal layer, with cells at different stages of destruction. In the dermis the larger arteries were empty. The connective tissue of the dermis was damaged (Fig. 15).

In summary, pathomorphological findings confirmed the clinical conclusions regarding the major contribution to the causes of death as damage to the vascular system and its effect on the internal organs as well as the significance of necrosis in the most highly exposed tissues (i.e. the tissues of the hands and arms).

9. FINDINGS AND LESSONS TO BE LEARNED

After carrying out a review following a radiological accident, the IAEA derives lessons to be learned from the accident, its consequences and the response to it, in order to disseminate them for the benefit of its Member States. Specific findings of the review conducted by the IAEA following the accident in Sarov follow, together with lessons to be learned (in *italics*).

9.1. OPERATING ORGANIZATIONS

9.1.1. Radiation safety

- (a) The engineering controls and safety rules that were in place at the Russian Federal Nuclear Centre at Sarov were reportedly considered to be adequate.

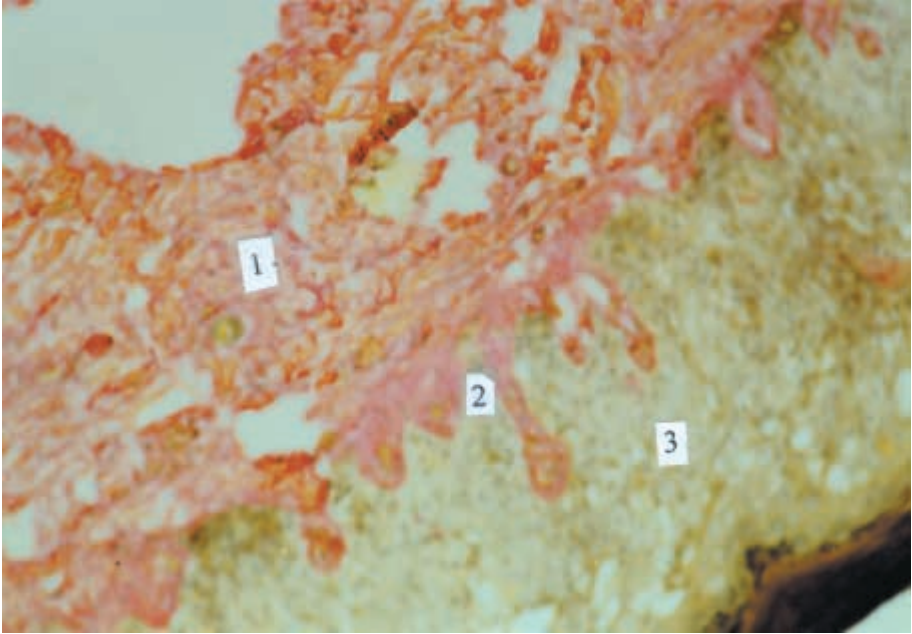

FIG. 15. Histology of skin autopsy material taken from a bulla. Notes: 1, strata cornea of destroyed and infiltrated oedematous epithelium; 2, basal membrane of epidermis without cell renewal; 3, oedema in dermis.

Nevertheless, these rules and controls failed to prevent this accident. In particular, the technician was working alone, reportedly in contravention of documented procedures.

- (i) *Having engineering controls and safety policies and procedures in place is not in itself sufficient to prevent accidents. A safety culture fostered and maintained within an organization encourages a questioning and learning attitude to protection and safety and discourages complacency (see BSS [22], para. 2.28). The preparation and implementation by management of a radiation protection programme is an essential element of the management of safety within the organization. The radiation protection programme should specify the responsibilities of managers and other persons and clearly identify lines of authority. It should also include appropriate arrangements for both routine surveillance of, and auditing of, operations, and periodic reviews of risk assessments, management systems and operating procedures (see Ref. [35]).*

- (ii) *Comprehensive safety assessments enable the probabilities and magnitudes of possible accidents to be determined so that measures can be taken to prevent them or to mitigate their consequences (see BSS [22], para. 2.37).*
- (iii) *Since it can be difficult to preclude with certainty the contravention of documented procedures, effective engineering controls need to be in place in areas where serious accidents could occur. Furthermore, in view of the risks posed by experiments with critical assemblies, the automation of processes wherever practicable needs to be considered.*
- (iv) *Regular training in radiation protection helps to maintain workers' awareness of both the hazards associated with their work and the reasons why procedures must be followed.*

9.1.2. Accident dosimetry

- (b) Analysis of biological samples and personal items such as clothing, spectacles and jewellery from accidentally exposed persons can provide valuable information about doses and dose distributions as input to decisions on medical treatment (especially in relation to bone marrow). Unfortunately, after the accident at Sarov, the technician's working clothes were reportedly mislaid.
 - (i) *After a radiation accident, any clothing or objects that could be analysed to help in the assessment of doses for the purposes of the prognosis and treatment of exposed persons need to be retained. Persons working in radiation areas where there is a possibility of an accidental criticality event need to be informed that, in the event of an accident, such items should not be disposed of.*
 - (ii) *Following an accident, details of the locations of potentially exposed persons at the time of the accident and the items of clothing they were wearing need to be recorded as accurately as possible.*
 - (iii) *Instructions given to staff need to include advice about the storing of samples and recording of relevant data. For example, each sample could be placed in a transparent plastic bag labelled on the outside.*
 - (iv) *The recording instructions need to stress the importance of identifying the orientation of samples or items (that is, which side was facing the radiation emitted by the fissile material and from which side (right or left) of the exposed person the samples came).*
 - (v) *Measurements of induced activity and their comparison with reference data allow a relatively accurate assessment of neutron doses. Measurements of induced ^{24}Na activity in the blood give an approximate*

estimate of the mean dose to the whole body, while measurements of activation by the $^{32}\text{S} (n, p) ^{32}\text{P}$ reaction in hair and nail tissue can provide information about the spatial distributions of doses.

9.2. THE MEDICAL COMMUNITY

- (a) The primary cause of the patient's death following the accident in Sarov was the direct radiation exposure of the blood vessels, leading to the rapid development of extensive oedema (swelling) and ultimately to heart failure. A number of factors may have contributed to heart failure, including hypocalcaemia (low blood calcium levels), progressive acidosis, lung oedema and hypoxaemia (low blood oxygen level), but in all likelihood it was a combination of some or all of these factors.

The management of patients who have been highly exposed may necessitate the involvement a number of medical specialists since there is likely to be radiation damage to several of the body's biological systems, such as bone marrow, gastrointestinal tract, lungs, central nervous system and skin. The varying rates of response of these systems leads to combinations of the various radiation syndromes, which makes the medical management of the patient particularly difficult. Medical facilities that may have to respond to radiological emergencies therefore need to have both appropriately trained staff and facilities for handling and treating patients with several different pathologies.

- (b) The general clinical course in this case was consistent with the technician having had a high radiation exposure. The rapid deterioration of several organs and tissues which resulted in his death within three days is consistent with the estimated whole body dose of over 14 Gy and considerably higher localized doses to the chest and head, as described in Section 6.
- (c) The patient died before either gastrointestinal radiation syndrome or bone marrow radiation syndrome could develop. Although death followed within three days of the exposure, it was apparently not due to effects on the central nervous system (there were reportedly no clinical indications of effects on the central nervous system).
- (d) The relatively mild expression of erythema and the severity of the oedema affecting the upper front part of the body and the arms in this case can be contrasted with the severe erythema and much milder oedema observed following other radiation accidents [13]. In addition, there is seemingly some inconsistency between the relatively moderate symptoms reported to

have been presented immediately after the accident and the early death of the patient.

- (e) Prodromal symptoms such as nausea, vomiting and diarrhoea are known to appear very soon after severe exposure. It is usually expected that the higher the dose the earlier such symptoms will appear and the more severe they will be. In the accident in Nesvizh [13] the technician concerned experienced nausea and vomiting after only 5–6 min, with severity increasing over a few hours, and the onset of diarrhoea was only 50 min after the exposure. (In that accident the whole body gamma dose was estimated to be in the range 10–15 Gy.) In contrast, in the present case the patient's symptoms reportedly were moderate and appeared rather late: vomiting did not start until 55 min after exposure, was relatively moderate and could readily be controlled by treatment, and there was no diarrhoea in the post-accident phase.

While, in general, delayed and moderate prodromal symptoms would indicate that an exposure were unlikely to be immediately life threatening, the present case demonstrated that very high radiation doses can result in only moderate early clinical signs. Therefore, prodromal symptoms are reliable in assessing the severity of an exposure only on the basis of positive indications: an absence of early and severe prodromal effects does not conclusively preclude a severe accident.

- (f) It is known that after a whole body radiation exposure the organs and tissues react in different ways and at particular rates which are related to cell replication and replacement. One common factor seems to be the response of vascular tissues, which is rapid and for some organs can lead to their irreversible damage. Evidently, the generalized radiation injury to the vascular system played a significant part in this case, being characterized by extensive damage to the microcirculatory capillary structure in several organs. This led rapidly to the appearance of interstitial oedema in the more highly exposed organs and the accumulation of fluid in the pleural and pericardial cavities. Other effects were thickening of the blood, hypovolaemia (reduction in the volume of circulating blood) and hypoxaemia (reduced levels of oxygen in the blood), kidney dysfunction, acidosis and reduced levels of albumin in the blood. There were also some signs of endogenous intoxication caused by necrotic processes in locally exposed tissues.

This case demonstrated the importance to the outcome of radiation damage to the vascular system. It illustrates the fact that the survival of an organ or tissue depends directly on the quality of its blood supply.

- (g) For doses above about 8 Gy, interstitial pneumonitis (lung inflammation) develops, which may lead to death after an extended period (up to one year). This type of injury is well known to radiotherapists, who protect the lungs of patients when other thoracic organs or tissues are treated with high radiation doses in radiotherapy. For the present case, the lung injuries, in contrast, were expressed early on and were severe, with extensive interstitial infiltration and oedema as well as, on the third day, fluid in the pleurae.
- (h) After a high radiation exposure, survival of the exposed person depends on the capability of each organ and tissue to respond to and recover from the radiation damage. If several organs and tissues have been exposed to varying extents in a fatal accident, it will always be difficult to determine the ultimate cause of death. In the present case, in spite of the moderate nature of the gastrointestinal symptoms over the first three days, there is no doubt that the patient would have developed gastrointestinal radiation syndrome, which would probably have proved fatal in view of the high estimated doses to the abdominal organs and tissues.
- (i) The present case demonstrates that, when a person is exposed to very high levels of radiation resulting in extensive cell death, haematological and cytogenetic dosimetry are of limited use, since the dose estimates so obtained are of a low accuracy. This is because cell death and cell damage cause lymphocytes to be removed from the bloodstream, making it difficult or impossible to produce a lymphocyte culture for the purpose of dose assessment.

REFERENCES

- [1] INTERNATIONAL ATOMIC ENERGY AGENCY, WORLD HEALTH ORGANIZATION, *Diagnosis and Treatment of Radiation Injuries*, Safety Reports Series No. 2, IAEA, Vienna (1998).
- [2] *Handling of Radiation Accidents (Proc. Symp. Vienna, 1969)*, IAEA, Vienna (1969).
- [3] *Handling of Radiation Accidents 1977 (Proc. Joint IAEA–OECD/NEA Symp. Vienna, 1977)*, IAEA, Vienna (1977).
- [4] JAMMET, H., GONGORA, R., LE GO, R., MARBLE, G., FAES, M., “Observation clinique et traitement d’un cas d’irradiation globale accidentelle”, *Radiation Protection (Proc. 1st Int. Congr. Rome, 1966)*, Pergamon Press, Oxford (1966).
- [5] JAMMET, H., GONGORA, R., LE GO, R., DOLOY, M.T., “Clinical and biological comparison of two acute accidental irradiation accidents: Mol and Brescia (1975)”, *Medical Basis for Radiation Accident Preparedness (HÜBNER, K.F., FRY, S.A., Eds)*, Elsevier, Amsterdam (1980) 91–104.
- [6] PARMENTIER, N.C., NENOT, J.C., JAMMET, H., “A dosimetric study of the Belgian and Italian accidents”, *ibid.*, pp. 105–112.
- [7] STRATTON, W.R., *A Review of Criticality Accidents*, Rep. No. LA-3611, Los Alamos National Laboratory, Los Alamos, NM (1967).
- [8] INTERNATIONAL ATOMIC ENERGY AGENCY, *Lessons Learned from Accidents in Industrial Irradiation Facilities*, IAEA, Vienna (1996).
- [9] INTERNATIONAL ATOMIC ENERGY AGENCY, WORLD HEALTH ORGANIZATION, *Planning the Medical Response to Radiological Accidents*, Safety Reports Series No. 4, IAEA, Vienna (1998).
- [10] INTERNATIONAL ATOMIC ENERGY AGENCY, *The Radiological Accident in Goiânia*, IAEA, Vienna (1988).
- [11] INTERNATIONAL ATOMIC ENERGY AGENCY, *The Radiological Accident in San Salvador*, IAEA, Vienna (1990).
- [12] INTERNATIONAL ATOMIC ENERGY AGENCY, *An Electron Accelerator Accident in Hanoi, Viet Nam*, IAEA, Vienna (1996).
- [13] INTERNATIONAL ATOMIC ENERGY AGENCY, *The Radiological Accident at the Irradiation Facility in Nesvizh*, IAEA, Vienna (1996).
- [14] INTERNATIONAL ATOMIC ENERGY AGENCY, *The Radiological Accident in Tammiku*, IAEA, Vienna (1998).
- [15] INTERNATIONAL ATOMIC ENERGY AGENCY, *Dosimetric and Medical Aspects of the Radiological Accident in Goiânia in 1987*, IAEA-TECDOC-1009, Vienna (1998).
- [16] INTERNATIONAL ATOMIC ENERGY AGENCY, *Accidental Overexposure of Radiotherapy Patients in San José, Costa Rica*, IAEA, Vienna (1998).
- [17] INTERNATIONAL ATOMIC ENERGY AGENCY, *The Radiological Accident in the Reprocessing Plant at Tomsk*, IAEA, Vienna (1998).
- [18] DERYABIN, O.R., ZAGORODNEV, V.A., KUZNECOV, V.V., “A Russian system of operations in extreme situations and warning of emergencies”, *Russian–American*

- Seminar on Elimination of Nuclear Weapon Accident Consequences, Russian Federal Nuclear Centre, Sarov (1997).
- [19] MIKHAILOV, V., Russia's key industry: A general description of the Russian Federation Ministry for Nuclear Power, *Int. Aff.* **70** (1994) 4.
- [20] NATIONAL COMMISSION ON RADIOLOGICAL PROTECTION, Russian Radiation Safety Standards, NRB-96, NCRP, Moscow (1996).
- [21] INTERNATIONAL COMMISSION ON RADIOLOGICAL PROTECTION, 1990 Recommendations of the International Commission on Radiological Protection, ICRP Rep. 60, *Ann. ICRP* 21 1–3 (1990), Pergamon Press, Oxford and New York (1991).
- [22] FOOD AND AGRICULTURE ORGANIZATION OF THE UNITED NATIONS, INTERNATIONAL ATOMIC ENERGY AGENCY, INTERNATIONAL LABOUR ORGANISATION, OECD NUCLEAR ENERGY AGENCY, PAN AMERICAN HEALTH ORGANIZATION, WORLD HEALTH ORGANIZATION, International Basic Safety Standards for Protection against Ionizing Radiation and for the Safety of Radiation Sources, Safety Reports Series No. 115, IAEA, Vienna (1996).
- [23] GUBANOV, V.A., "The system of safety assurance for facilities of the Ministry of Atomic Energy of the Russian Federation during normal operation and emergencies", Nuclear Materials Safety Management (PEDDICORD, K.L., LAZAREV, L.N., JARDINE, L.J., Eds) Kluwer, Dordrecht and New York (1998) 49–64.
- [24] BESPALOV, A.F., DERYABIN, O.R., SMITHS, A., "A subsystem of the Ministry of Atomic Energy of Russia to respond to nuclear emergencies", Russian–American Seminar on Elimination of Nuclear Weapon Accident Consequences, Russian Federal Nuclear Centre, Sarov (1997).
- [25] BELUGIN, V.A., Russian Federal Nuclear Center VNIIEF is completely open, *J. Atom. Energy* **8** 3 (1996) 8–9 (in Russian).
- [26] PUNIN, V.T., SMIRNOV, I.G., ZYKOV, S.A., Failure on the stand of a critical assembly in the Russian Federal Nuclear Centre VNIIEF (Information), *J. Atom. Energy* **8** (1997) 154–156 (in Russian).
- [27] KHODALEV, G.F., TARASOV, E.YU., ZHITNIK, A.K., Exposure of a victim in an accident with a critical assembly in the Russian Federal Nuclear Centre VNIIEF, *J. Atom. Energy* **8** (1998) 153–158 (in Russian).
- [28] KRAITOR, S.N., Dosimetry in Radiation Accidents, Atomizdat, Moscow (1972) (in Russian).
- [29] ZOLOTUHIN, V.G., KEIRIM-MARKUS, I.B., KOCHETKOV, O.A., Tissue Doses of Neutrons in the Human Organism, Atomizdat, Moscow (1972) (in Russian).
- [30] INTERNATIONAL ATOMIC ENERGY AGENCY, INTERNATIONAL LABOUR ORGANISATION, WORLD HEALTH ORGANIZATION, Health Surveillance of Persons Occupationally Exposed to Ionizing Radiation: Guidance for Occupational Physicians, Safety Reports Series No. 5, IAEA, Vienna (1998).
- [31] PYATKIN, E.K., BARANOV, A.E., Biological assessment of dose by means of the analysis of chromosome aberrations and counting of cells in peripheral blood, *Acad. Sci. USSR, Series Rad. Biol.* **3** (1980) 103–179 (in Russian).

- [32] PYATKIN, E.K., NUGIS, V.YU., CHIRKOV, A.A., Analysis of chromosome aberrations for evaluation of severity of the bone marrow syndrome of radiation disease, *J. Hematol. Blood Transfusion* **36** 10 (1991) 21–26.
- [33] BOCHVAR, I.A., KLESHENKO, U.D., KUSHNEREVA, K.K., LEVOCHKIN, F.K., About the sensitivity of human tooth enamel to alpha radiation and neutrons, *J. Atom. Energy* **83** 5 (1997) 380–383 (in Russian).
- [34] ILYIN, L.A., SOLOVYEV, V.J., BARANOV, A.E., “Retrospective analysis of direct medical consequences of radiation incidents leading to overexposure of humans occurring in the former USSR”, *Radioecological, Medical, Social and Economic Consequences of the Chernobyl Accident: Rehabilitation of the Area and Population (Proc. Conf. Golitsino, 1995)*, Nuclear Safety Institute of the Russian Academy of Sciences, Moscow (1995) 64 (in Russian).
- [35] INTERNATIONAL ATOMIC ENERGY AGENCY, INTERNATIONAL LABOUR OFFICE, *Occupational Radiation Protection, Safety Standards Series No. RS-G-1.1*, IAEA, Vienna (1999).

CONTRIBUTORS TO DRAFTING AND REVIEW

| | |
|--------------------|--|
| Barabanova, A.V. | Institute of Biophysics of the Ministry of Health, Russian Federation |
| Baranov, A.E. | Institute of Biophysics of the Ministry of Health, Russian Federation |
| Belovodskij, L.F. | Federal Nuclear Centre, Sarov, Russian Federation |
| Cvetkov, V.I. | Institute of Biophysics of the Ministry of Health, Russian Federation |
| Gusev, I.A. | Institute of Biophysics of the Ministry of Health, Russian Federation |
| Gustafsson, M. | International Atomic Energy Agency |
| McDonnell, C.E. | National Radiological Protection Board, United Kingdom |
| Kalashnikov, M.V. | Federal Nuclear Centre, Sarov, Russian Federation |
| Khodalev, G.F. | Federal Nuclear Centre, Sarov, Russian Federation |
| Kleschenko, E.D. | Institute of Biophysics of the Ministry of Health, Russian Federation |
| Kochetkov, O.A. | Institute of Biophysics of the Ministry of Health, Russian Federation |
| Kolganov, A.V. | Institute of Biophysics of the Ministry of Health, Russian Federation |
| Konchalovski, M.V. | Institute of Biophysics of the Ministry of Health, Russian Federation |
| Nénot, J.C. | Institut de protection et de sureté nucléaire, France |
| Panfilov, A.P. | Ministry for Atomic Energy, Russian Federation |
| Protasova, T.G. | Institute of Biophysics of the Ministry of Health, Russian Federation |
| Ricks, R.C. | Radiation Emergency Assistance Center and Training Site, United States of America |
| Selidovkin, G.D. | Institute of Biophysics of the Ministry of Health, Russian Federation |
| Tarasova, E.Yu. | Federal Nuclear Centre, Sarov, Russian Federation |
| Tumanov, Yu.A. | Federal Nuclear Centre, Sarov, Russian Federation |
| Turai, I. | International Atomic Energy Agency |

| | |
|---------------|---|
| Wrixon, A.D. | International Atomic Energy Agency |
| Wheatley, J. | International Atomic Energy Agency |
| Zhitnik, A.K. | Federal Nuclear Centre, Sarov, Russian Federation |

Consultants Meetings

Vienna, Vienna: 23–25 September 1998, 8–12 March 1999, 3–4 February 2000